

**ROUTING OPTIMIZATION FOR WIRELESS SENSOR
NETWORKS USING FUZZY LOGIC-ANT COLONY**

VERONICAH MWENDE MUALUKO

EE300-0009/16

**A Thesis submitted to Pan African University Institute for Basic
Science,
Technology and Innovation in partial fulfillment of the requirements
for the
award of the degree of Master of Science in
Electrical & Electronic Engineering (Telecommunication option)**

2018

DECLARATION

This thesis is my original work, except where due acknowledgement is made in the text, and to the best of my knowledge has not been previously submitted to Pan African University or any other institution for the award of a degree or diploma.

NAME: VERONICAH MWENDE MUALUKO

REG. No. EE300-0009/16

SIGNATURE----- DATE -----

TITLE OF THESIS: ROUTING OPTIMIZATION FOR WIRELESS SENSOR NETWORKS USING FUZZY LOGIC-ANT COLONY

PROGRAMME: MASTER OF SCIENCE IN ELECTRICAL & ELECTRONIC ENGINEERING (TELECOMMUNICATION OPTION)

SUPERVISOR CONFIRMATION:

This thesis has been submitted to the Pan African University Institute for Basic Science, Technology and Innovation with our approval as the supervisors:

1. Name: Dr. Peter K. Kihato Signature:.....
Date:.....

JKUAT

2. Name: Prof. Vitalice Oduol Signature:.....
Date:.....

The University of Nairobi

DEDICATION

I dedicate this thesis to my God, family, classmates and all my friends for the support and encouragement throughout my education and life. Special dedication goes to my loving husband Felix, my daughter Madelyn, my sisters and my mother Agnes for their support and prayers during my research work.

ACKNOWLEDGEMENT

My sincere gratitude goes to the Almighty God for sustaining me this far in pursuit of my education. I also give special thanks to my supervisors, Prof. Oduol and Dr. Kihato for the advice, direction, support, guidance and mentorship through the research period, not forgetting my classmates for their moral support. I would also like to express gratitude to the Pan African University Institute of Science, Technology and Innovation and Japan International Cooperation Agency (JICA) for their support especially in funding of this research work.

TABLE OF CONTENTS

DECLARATION	i
DEDICATION	ii
ACKNOWLEDGEMENT	iii
LIST OF FIGURES	vii
LIST OF TABLES	vii
LIST OF ABBREVIATION AND SYMBOLS	viii
ABSTRACT	xi
CHAPTER ONE	1
INTRODUCTION	1
1.1. Background Information	1
1.2 Statement of the Problem	2
1.3 Justification	3
1.4 Objectives.....	3
1.4.1 Main Objective.....	3
1.4.2 Specific Objectives	3
1.5 Scope of the Study.....	4
CHAPTER TWO	5
LITERATURE REVIEW	5
2.1 Introduction	5

2.2	Communication Protocols for WSNs	8
2.3	Network Topologies for WSNs.....	9
2.3.1	Star Topology	10
2.3.2	Cluster Tree Topology	10
2.3.3	Mesh Topology.....	11
2.4	Routing Protocols for WSNs	12
2.5	Related Work and Summary of Research Gaps.	16
CHAPTER THREE		20
RESEARCH METHODOLOGY AND DESIGN		20
3.1	Introduction	20
3.2	Research Design and Routing Model.....	20
3.2.1	Fuzzy Logic.....	20
3.2.2	Ant Colony Algorithm	25
3.3	Data Collection Procedure.....	28
3.3.1	Routing Algorithm	28
CHAPTER FOUR.....		31
RESULTS AND DISCUSSIONS		31
4.1	Routing Model for WSN.....	31
4.2	Simulation of Model in Matlab C code using Ant Colony and Fuzzy Logic.....	33
4.2.1	Simulation Output.....	35

4.3 Performance Comparison of Designed Routing Algorithm with Existing Technique	49
CHAPTER FIVE	55
CONCLUSIONS AND RECOMMEDATIONS	55
5.1 Conclusions	55
5.2 Recommendations	56
REFERENCES	57
APPENDICES	63
Appendix A: Simulation Code	63
Appendix B: Publication.....	64

LIST OF FIGURES

Figure 2.1 Model of a sensor network	6
Figure 2.2 Various parts of a sensor node for measuring pressure	7
Figure 2.3 Industrial wireless sensors that have been installed in the world over the years.....	8
Figure 2.4 WSNs network topologies	10
Figure 2.5 Routing protocol categories.....	14
Figure 2.6 First order radio model for WSNs.....	15
Figure 3.1 Fuzzy system for calculating the node cost.....	21
Figure 3.2 System architecture.....	30
Figure 4.1 Routing model for WSNs.....	32
Figure 4.2 WSNs deployment.....	34
Figure 4.3 Membership function for energy input of sensor node.....	36
Figure 4.4 Membership function for data input	37
Figure 4.5 Membership function for node cost output.....	38
Figure 4.6 Fuzzy rules.....	40
Figure 4.7 Fuzzy rule viewer.....	43
Figure 4.8 Surface viewer for fuzzy system.....	44
Figure 4.9 Energy level versus number of cycles.....	45
Figure 4.10 Packets delivered to sink node versus number of cycles.....	46
Figure 4.11 Number of dead nodes versus number of cycles.....	47
Figure 4.12 Performance of FACO compared to ACO for packet delivery.....	49
Figure 4.13 Performance of FACO compared to ACO for number of dead nodes.....	51
Figure 4.14 Performance of FACO compared to ACO for energy level.....	52

LIST OF TABLES

Table 2.1 Communication protocol for WSNs	9
Table 4.1 Simulation parameters.....	33
Table 4.2 Fuzzy rules in tabular form	40
Table 4.3 Fuzzification representation	41
Table 4.4 Ant colony parameter initialization	45
Table 4.5 Performance comparison of FACO and ACO on network lifetime.....	54
Table 4.6 Performance comparison of proposed technique with other techniques.....	53

LIST OF ABBREVIATION AND SYMBOLS

ABC	Artificial Bee Colony
ACO	Ant Colony Optimization
AI	Artificial Intelligence
ADC	Analog to digital Converter
ANFIS	Adaptive Neuro-Fuzzy Inference System
BFS	Breadth First Search
bps	bits per second
DD	Directed Diffusion
DDDC	Directed Diffusion Data Centric
DV	Distance Vector
FACO	Fuzzy Logic Ant Colony Optimization
FL	Fuzzy Logic
FLC	Fuzzy Logic Controller
GA	Genetic Algorithm
GEAR	Geographic and Energy Aware Routing
GPSR	Greedy Perimeter Stateless Routing
IEEE	Institute of Electrical and Electronics Engineers
IP	Internet Protocol
IOT	Internet of Things
LAN	Local Area Network
LEACH	Low-Energy Adaptive Clustering Hierarchy
LPA-star	Life Long planning A* search Algorithm
MAC	Medium Access Control
MEMS	Microelectromechanical Systems
MIT	Massachusetts Institute of Technology
NN	Neural Network
OSI	Open Systems Interconnection
OSPF	Open Shortest Path First

PAN	Personal Area Network
PSO	Particle Swarm Optimization
PEGASIS Information Systems	Power-Efficient Gathering in Sensor
QOS	Quality of Service
RIP	Routing Information Protocol
RX	Receiver
SPEED	Stateless Protocol for End to End Delay
SI	Swarm Intelligence
SPIN Negotiation	Sensor Protocols for Information via
TX	Transmitter
TBF	Trajectory Based Forwarding
UCLA	The University of California Los Angeles
UWB	Ultra Wideband
WiMax Access	Worldwide Interoperability for Microwave
WSNs	Wireless Sensor Networks

ABSTRACT

It is essential to find and maintain routes in Wireless Sensor Networks (WSNs) because of energy restrictions as they run on battery. Also WSNs are prone to sudden changes for example due to node failure or unpredictable topological changes. For us to reduce energy consumption in WSNs the design of routing technique is very key. The purpose of this research work is to design a routing technique that will reduce the level of energy consumption and increase the network performance by considering three key parameters namely the distance between source node and the gateway, the energy of the sensor node and the amount of data in the queue for the sensor node.

In WSNs the nodes which are near the sink or the gateway are used to forward or direct the data for the nodes which are far away from the sink. This means that the nodes closer to the sink will get drained faster in terms of power because they have to send the data of the nodes which are far away from the sink node together with their own data. In order to avoid nodes from failing there is need to design a routing protocol that is aware of the energy of the sensor nodes, the data in the queue and the distance to the sink node. The sink node is the one that sets up the routes for each sensor node.

The routing protocol used is based on Fuzzy Logic and Ant Colony Optimization (FACO). The use of Fuzzy Logic (FL) is to compute the overall cost of each node to the gateway by considering the data load in the node and the energy of the node. The Ant Colony Optimization (ACO) algorithm is used in this work to find and evaluate the shortest route from the source sensor node to the gateway (sink node) which is determined by the shortest distance. The designed protocol showed an improved performance and a routing balance between the network performance and the network

lifetime. The number of packets delivered increased by 18.25 %, the number of dead nodes decreased by 40 % meaning more nodes were available for data transmission and the energy level increased by 100% for FACO as compared to ACO routing protocol. This protocol can be used for communication in WSNs especially for industry based applications.

CHAPTER ONE

INTRODUCTION

1.1. Background Information

WSNs are composed of several sensors which are randomly or deterministically distributed for data acquisition and to forward the data to the gateway for further analysis. WSNs are used in many applications such as in health care for in patient monitoring; in utilities such as electricity grid, streetlights and water distribution in municipalities; in remote monitoring for example to monitor the condition of water, soil or bridges; in industries to monitor the state of equipment and detect any malfunction during normal production activity. In general, WSNs take measurements of the desired application and send this information to a gateway, whereby the user is able to interpret the information to achieve the desired purpose. The main importance of WSNs in area of machine monitoring is that they can be placed in a rotating machinery, or in a place which is un reachable for the engineer to take measurements by hard wired sensors.

WSNs routing protocols are designed to establish routes between the source and destination nodes. What these routing protocols do is that they decompose the network into more manageable pieces and provide ways of sharing information among its neighbors first and then throughout the whole network. The traditional routing protocols which have been in existence are divided mainly into three; network organization routing protocol, route discovery routing protocol and protocol operation routing protocol. However, these traditional protocols do not perform well as compared to Artificial Intelligence (AI) routing protocols. Other routing protocols such as Open

Shortest Path First (OSPF) and Distance Vector (DV) have not been considered because they are based on distance only. Since WSNs are limited in energy we need to consider other factors which lead to energy consumption apart from distance only. These factors include the energy of the sensor node and the data in the queue.

The importance of using AI techniques to perform routing of WSNs is that the system operation is energy aware, distance aware and data aware. If such a routing algorithm is used in industrial applications, it will lead to energy conservation and efficiency.

1.2 Statement of the Problem

The main problem of WSNs is energy limitation. Energy factor is very crucial when designing a routing protocol for WSNs even if the sensor is running on external solar energy or other form of renewable energy. Wireless sensors are designed to run on battery which is not a reliable source and can go on a few days depending on the application in use. For us to avoid sensors from failing out quickly leading to network failure and unreliability an energy aware routing is very essential. The other problem of WSNs is the bandwidth, the data that is transmitted to the sink node is reduced to avoid redundant or unnecessary data transmission which can lead to energy wastage of sensors. Therefore, it is very important to design a routing protocol that will efficiently lead to minimum energy consumption of the sensor nodes.

In this work the applied protocol has used FACO to find the optimal path from source node to the sink node to improve the network lifetime. Generally speaking, various machine learning algorithms have been proposed by different researchers to enable WSNs to perform routing in a dynamic environment. Most of these machine learning

algorithms are adaptive and can greatly provide energy efficient communication in WSNs. These machine learning algorithms include Neural Network (NN), FL and Swarm Intelligence (SI) [1][2].

1.3 Justification

WSNs are cheaper in cost and require little or no maintenance once installed hence the need for using them for various applications. For these applications to be efficient and reliable, there is need to design a routing optimization protocol to manage the communication of WSNs in energy aware, data aware and distance aware mechanism.

The designed routing protocol is modified to take extra considerations like the data load on the sensor nodes in addition to the other considerations for example the energy available in the node and the minimum distance between the source node and the destination node. These additional considerations will enhance energy efficiency and reliability for WSNs.

1.4 Objectives

1.4.1 Main Objective

The main objective is to develop an efficient routing optimization protocol for wireless sensor network using ant colony optimization algorithm and fuzzy logic technique.

1.4.2 Specific Objectives

- To develop a model of routing for wireless sensor network.
- To simulate the model in Matlab using ant colony algorithm and fuzzy logic to achieve minimum energy usage within the nodes

and to use the optimum shortest path possible from source to the sink node.

- To analyze the performance of proposed routing protocol and compare with other related existing routing protocol.

1.5 Scope of the Study

This study focused on performing a routing optimization for WSNs. The main aim is to apply FACO for routing to improve the communication performance and reliability of WSNs. The issue of concern in this research is the battery life for WSNs. To increase the battery life of WSNs, the routing protocol is designed to allow sensors with the highest score to be allowed to transmit data while the sensors with a lower score are allowed to stay on standby for the next round of sending information to the sink node. The proposed routing technique uses FACO.

This research focused on designing a routing protocol that is energy efficient considering three factors namely; total energy of the sensor network; minimum distance; and data load on nodes. The routing protocol was written in Matlab C code and the results simulated. No physical implementation was done because the time frame and resources did not allow both simulation and hardware implementation.

CHAPTER TWO

LITERATURE REVIEW

2.1 Introduction

In the world of today a key interest is focused on industrial automation. Wired sensors are being replaced by WSNs because wireless sensors are portable and cheaper as compared to their counterpart. It is seen that in the 20th century the technology of WSNs did not exist as much but over the years in the 21st century, they have been used to solve engineering problems in the areas of academics and in the industry. The following are the evolutions of wireless sensors: The University of California Los Angeles (UCLA) wireless integrated network sensors, University of California at Berkeley pico radio program, μ adaptive multi-domain power aware sensors program at Massachusetts Institute of Technology (MIT), sensor webs, ZigBee alliance and center for embedded network sensing. In the case of WSNs with ZigBee technology the battery life duration is limited to three years [1].

The technological improvement of wireless sensors over the years will combine in the future to make the nervous system of the Internet of Things (IOT). When this future of WSNs technology is combined with cloud computing and big data processing the end users will be able to control a lot of activities. For this reason, also the market share will increase with the number of applications and the life of human beings will be greatly improved by reducing the man power required to perform various operations.

WSNs are built of several standards including: Institute of Electrical and Electronics Engineers (IEEE) 802.11a/b/, IEEE 802.15.1 Personal Area Network (PAN)/Bluetooth, IEEE 802.15.3 Ultra Wideband (UWB), IEEE 802.15.4/ZigBee, IEEE 802.16 WiMax, IEEE 1451.5 wireless sensor working group and mobile Internet Protocol (IP) standard [2].

Figure 2.1 illustrates a model of a sensor network. WSNs have several sensor nodes which are embedded in the sensor field to capture the required data which is forwarded to a common gateway or a sink node (base station). The data from the gateway is forwarded to the observer remotely via the internet. The sink node is the network controller and it is responsible for setting up the routes for each sensor node. It also acts as a gateway(destination) for WSNs to collect all the data from the network [3].

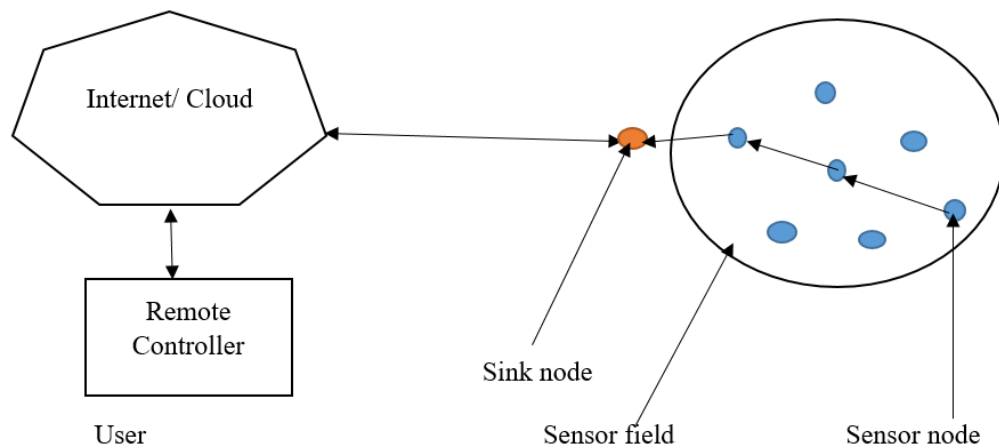

Figure 2.1 Model of a sensor network

Figure 2.2 shows a sensor node comprised of several parts which are: a unit used for sensing and actuation, it is composed of one or more sensors; a unit for processing, which forms the memory of the sensor; a unit for communication, which is comprised of

a transceiver with an internal and external antennas for purpose of data transmission ; a unit for power, which includes the battery; and other units for other applications which include the Location finding system, power generator and an actuator [4] [5].

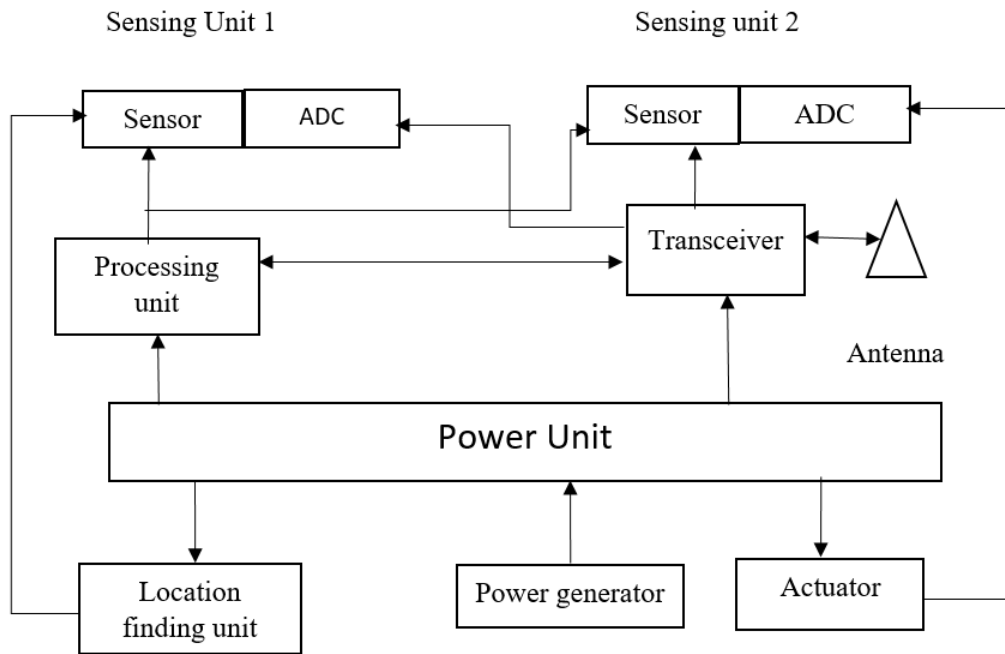

Figure 2.2 Various parts of a sensor node for measuring pressure

A sensor node has an in built radio transceiver with an internal antenna to an external antenna, a microcontroller, an electronic circuit for interfacing with the sensors and an energy source which is a battery and a platform for allowing external energy supply if required especially for the sink node. Industries manufacturing WSNs are looking forward to produce complete Microelectromechanical Systems (MEMS) based sensor systems at a volume of 1 mm^3 . Wireless sensors are relatively inexpensive but the cost will depend on the application and other factors like the memory of the sensor, the energy of the sensor, the operating speed of the sensor as well as the size of the sensor [5].

Figure 2.3 shows a worldwide survey that was done to show the increase of wireless sensors installed by the year of 2016. WSNs have increased its market in the industry applications by over 20% and other market for new applications that do not rely on hard wired sensors with a share of 60% [6] [7]. From the survey shows there has been and still is an increase in the number of installed industrial wireless sensors over the years.

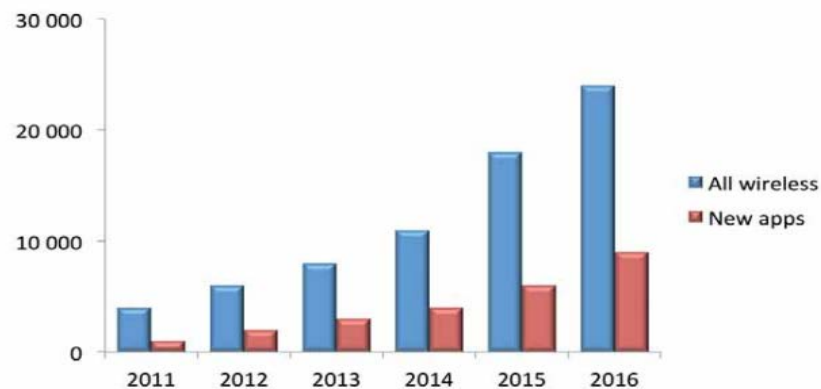

Figure 2.3 Industrial wireless sensors that have been installed in the world over the years

2.2 Communication Protocols for WSNs

Several researches have been done by different authors to save energy usage of WSNs. The researchers have focused on routing protocols because these protocols may be different from the traditional networks [8]- [11].

Table 2.1 shows a reference communication protocol which is in reference to the Open Systems Interconnection (OSI) reference model used to describe the communications in WSNs. The upper layers (application, presentation and session) in the network are the ones used for communication purpose and they include the application processing, data aggregation, external query processing and external database. The other layers in the communication protocol are; Layer 4 which is the transport layer and its work is to

provide error correction and to work with other layers to enable packets to be send and received without errors; Layer 3 is the networking layer and its work is to forward packets and perform routing; Layer 2 is the data link layer and is concerned with delivery of frames between devices connected on the same Local Area Network (LAN), the data link layer also includes channel sharing Medium Access Control (MAC), timing; and Layer 1 is the physical medium which is the communication channel for sensing, actuation and signal processing [12].

Table 2.1 Communication protocol for WSNs

Application Layer-Layer 7
Presentation Layer-Layer 6
Session Layer-Layer 5
Transport Layer-Layer 4
Network Layer-Layer 3
Data Link Layer-Layer 2
Physical Layer-Layer 1

2.3 Network Topologies for WSNs

Figure 2.4 displays the most commonly used WSNs topologies which are star, cluster tree or mesh network topologies. The star topology is one where each node is connected directly to the sink node. The cluster tree network forms a cluster head to represent each cluster, the cluster head then connects to a node which is higher in the tree and then to the sink node. Mesh topology is one where each node is connected to several nodes by forming several paths to the sink node. Mesh topology is also called a router [13].

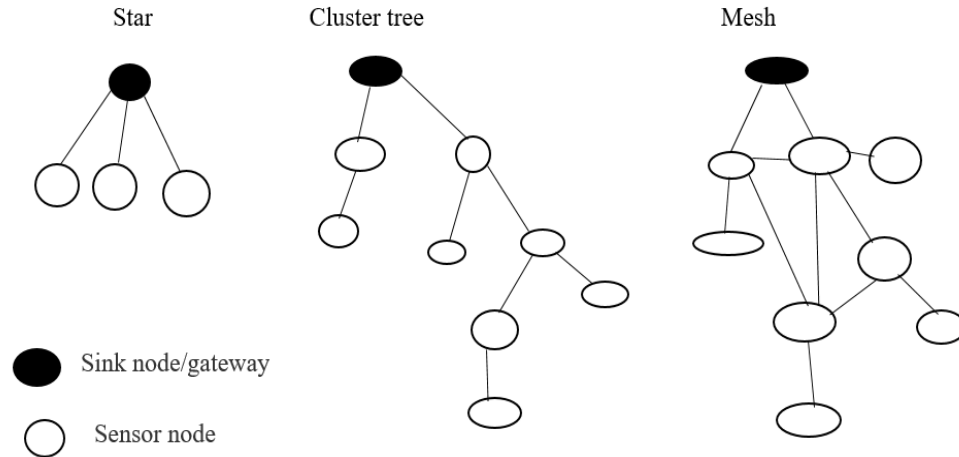

Figure 2.4 WSNs network topologies

2.3.1 Star Topology

A star topology is one in which the nodes are connected to a centralized hub or a gateway. The transmission of information is routed through the gateway. This is done by naming the nodes as clients and the gateway as the router. Reference [14] proposed a routing technique for WSNs to improve the life of a battery using FL and an A-star algorithm. It used a star topology in the algorithm.

Star topology is able to simplify the network because it has minimum networking issues, but its biggest challenge is the issue of scalability. Nodes deployed far away from the gateway or the hub will have bad quality connection with the hub. Therefore, star topology is used where the coverage area is small or within the range of radio transmission.

2.3.2 Cluster Tree Topology

Cluster topology is mainly used in applications for larger WSNs. In this topology the devices in the lower tier send their information to a local cluster head and in turn the

cluster head sends the information to the gateway in the upper tier. The main advantage of cluster tree topology is that it partitions the entire network into small clusters where information is routed to a cluster head locally. The cluster head is the one that is responsible for transmitting the data to the sink node. According to [15] the proposed method makes use of cluster topology in WSNs to increase the network battery and also use of Low-Energy Adaptive Clustering Hierarchy (LEACH) protocol ,which is one of traditional routing protocols for WSNs. The LEACH protocol uses a local cluster head that is able to distribute the energy evenly in the WSNs. The limitation of LEACH protocol is that it only considers one parameter for routing which is the energy of a sensor node.

2.3.3 Mesh Topology

In mesh topology data can be sent via several paths from source node to the gateway. This topology has the ability to keep the list of nodes that have been given the access to use the network. When the node wakes up the radio is turned to ON state and is able to scan the network, locate the sink node in order to join the network and begin taking the required measurements. For the reason that each node is joining the network upon its wake up, there is a possibility of finding an alternative path to the sink node in case some paths are not available for data transmission.

The main advantage of this topology is that it is fault tolerant in case of a failure of one link an alternative link can be established to route information to the gateway. However, this topology disadvantage is that the network performance may decrease because each node must hop to get its messages back to the gateway.

2.4 Routing Protocols for WSNs

The aim of WSNs is to perform sensing and to acquire the desired information from a source node, process the information and send it to a gateway for analysis depending on the kind of application in use. In order to perform these tasks efficiently and appropriately there is need for a routing protocol that is energy aware, data aware and distance aware so as to establish optimum routes between source sensor nodes and the sink node. This route selection is referred to as routing and must be done in a way that WSNs battery life is extended in an optimum way. One of the main challenges of the sensor network is energy limitation within the operating environment making the routing problem very challenging. A reliable design of routing protocols for WSNs should consider that the power in these sensors is limited and so energy factor must be considered in their designs [16].

The choice of a routing protocol in WSNs is generally made based on the following factors; sensor node physical placement, energy in the sensor node, data delivery model, fault tolerance, scalability, network dynamics, transmission media, connectivity, coverage, data aggregation/converge cast and quality of service. In node placement, the physical placement of sensors depends on the type of application in use. This sensor placement can be deterministic or random depending on where exactly the measurements are to be taken. Deterministic sensor placement method allows the engineer to manually place the sensors through established or pre-determined routes. Random node placement allows the engineer to randomly place the sensors in the desired area of sensor measurement. In the case of the energy in the sensor network nodes in the network can drain their energy when doing computations and sending data

to the gateway which may be located a bit far from its area of physical connection. In order to conserve this limited energy, the ways of communication and computation are important. For the case where a sensor node has several hops to the sink node, the sensor node will perform both the dual role of data acquisition and data sender. In the event that a sensor network might fail due to energy depletion, there can be a significant topological change which might result in rerouting of packets and reorganization of the network [15].

Figure 2.5 shows the routing protocols for WSNs; Flat routing include Sensor Protocols for Information via Negotiation (SPIN) and Directed Diffusion (DD); Hierarchical routing include LEACH (Low-Energy Adaptive Clustering Hierarchy) protocol, and PEGASIS (Power-Efficient Gathering in Sensor Information Systems) ;Location based routing include GEAR (Geographic and Energy Aware Routing) protocol and GPSR (Greedy Perimeter Stateless Routing); Negotiation based routing include SPIN; Multi-path network routing include DD (Directed Diffusion); Query based routing include DDDC (directed-diffusion- Data Centric routing); QOS based routing include TBP (Trajectory Based Forwarding) and SPEED (Stateless Protocol for End to End Delay); Coherent based routing include DD (directed diffusion); The proactive strategy is the strategy where routing information is forwarded periodically so as to keep accurate and consistent routing tables. Flat proactive routing strategies are used to find optimal paths. Reactive routing strategies determine paths to a limited number of destinations. Hybrid strategies base their routing technique on the structure of the network to gain scalability and stability for large networks. A hybrid routing strategy can be used but proactive routing is adopted in a cluster while a reactive routing is adopted across clusters [18].

Other traditional routing protocols include Open Shortest Path First (OSPF), a protocol which is based on the open shortest path first. Distance Vector (DV) routing protocol manipulates vectors of distances to other nodes in the network.

The above traditional routing protocols are not effective since they consider only one factor in evaluating the shortest distance between the source node and the sink node. For example, OSPF and DV consider the distance only, LEACH protocol considers the energy only, GEAR protocol considers only the locality of the sensor node. Other routing mechanisms which are more advanced as compared to the methods above are based on machine learning. The routing mechanisms that can be used are in AI and can perform better in relation to above traditional routing techniques. They include; FL, NN and SI algorithms [17]- [21].

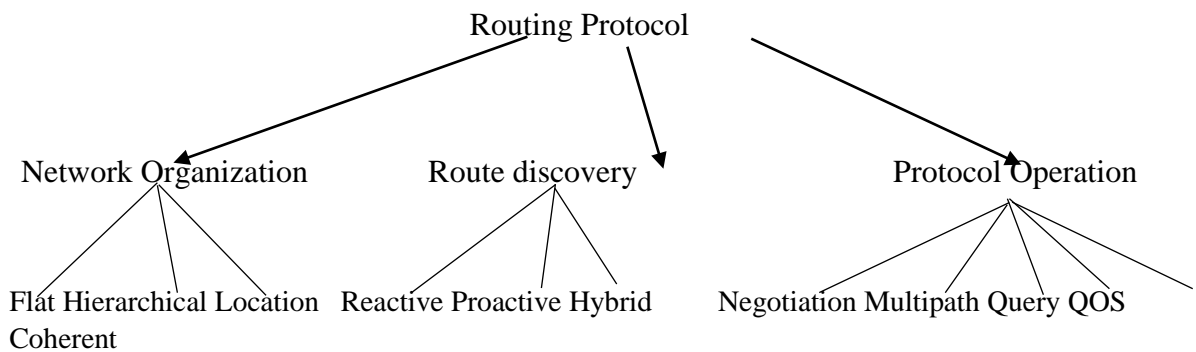

Figure 2.5 Routing protocol categories

In Figure 2.6, for communication to be established between two sensors the energy usage during information transmission (E_{TX}) is calculated by first order radio model from equation (2.1) [22] [20] [24].

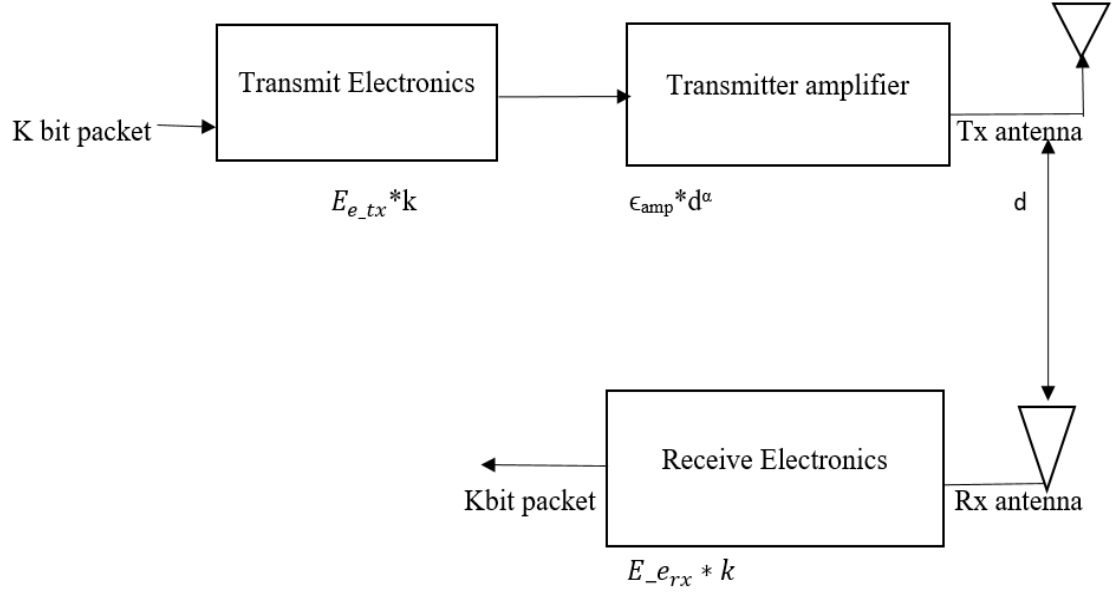

Figure 2.6 First order radio model for WSNs

$$E_{TX} = E_{e_tx} * k + \epsilon_{amp} * d^\alpha \quad (2.1)$$

In the above equation K represents the number of data bits that have been sent; α is a constant value that is between 2 and 5; d is the distance between two sensor nodes; ϵ_{amp} is the amplification coefficient that enables minimum bit error rate; and E_{e_tx} is the amount of dissipated energy to operate the transmitter, it is shown in equation (2.2).

$$E_{e_tx} = V_{CC} * I_{TP} / K_{data_rate} \quad (2.2)$$

V_{CC} represents the working voltage, I_{TP} represents the transmission current, and K_{data_rate} represents the information transmission rate. The energy usage for information reception is given by equation (2.3).

$$E_{RX} = E_{e_rx} * k \quad (2.3)$$

If the distance is fixed, then the energy usage is directly proportional to the number of data bit, this is from equation (2.1).

2.5 Related Work and Summary of Research Gaps.

The major challenges of WSNs is energy efficiency, responsiveness, robustness, self-configuration and adaptation. Research has been done within the past years to determine the optimal path for a WSNs minimizing energy consumption between the source node and destination node. However, the challenge has been to create a good routing algorithm taking into consideration the major challenges mentioned above.

Reference [14] proposed a routing optimization design of WSNs based on the residual energy of the sensor node, minimum hop counts; and data burden on nodes. The algorithm was LPA-star algorithm (Lifelong planning star search algorithm) combined with FL. The algorithm employs LPA star algorithm to find the route between the source node and the destination node in a dynamic environment. The algorithm used does not perform well because it uses a star topology meaning nodes deployed far away from the sink node will have bad quality connection to the sink node.

Reference [25] designed a leakage detection system that used WSNs in a pipeline that allowed a number of sensors running on low power to be used to check a leakage in the pipeline as well as determine the size of the leakage. The model was able detect small leakage and estimate the size of the leakage, and also train the system. The algorithm used reduces the overall communication cost because the sensors only send data about leakage status to the gateway. The algorithm used a pattern recognition to enable the WSNs to learn and adopt to new changes in the environment of leakage in the pipeline. The algorithm used here only considers the amount of energy in a sensor node to determine which route will be used.

Reference [26] conducted a research by placing wireless sensors at the contact points of distribution transformer. The author compared WSNs technology with other technologies which include; fiber-optic thermometry technology which utilizes an optical temperature sensor on optical fiber to measure temperature, a thermal infrared detector technology which makes use of; a thermal infrared measuring device, traditional contact measurement and the use of color chip to measure transformer status. The routing algorithm used here only considers the shortest distance between source node and destination.

Reference [27] discussed the reason why WSNs deployment in industry is essential for improving the efficiency at industries. The discussion is how the placement of sensors in the industry for control purpose is important. Further, the sensors can be placed on a rotating machinery to monitor the status while at the same time the machine is in normal operating mode. The author insists how this can improve the productivity and efficiency of a company by avoiding unnecessary downtime of a machine.

Reference [28] provided a critical analysis of various Machine Learning for Wireless Sensor Network used to transmit information to the sink node in a way that extends the battery lifetime and improve the network reliability. The authors also provide a review of the known possible algorithms, their challenges and applications. The mentioned techniques include FL, NN and SI. The author further recommends machine learning techniques to optimize WSNs.

Reference [29] proposed ACO to enhance the accuracy of the best path selection. The ACO algorithm the author proposed consist of three type of ants, namely the frontward

ant, the Bfrontward ant and the backward ant. The frontward ant is used to find the best and shortest path by looking up the information on neighboring nodes from the routing table. A backward ant is used for the same path back as frontward ant, while using the algorithm to adapt to the network changes. The last ant which is Bfrontward ant and was used to enhance the ability to predict the cost of selecting the next node as a path to send data for the next level of transportation. The limitation of this protocol is that it considers only the shortest distance between source node and the sink node.

Reference [30] used a termite hill algorithm for routing, this termite hill algorithm is also known as ant colony optimization algorithm. In this routing algorithm the only factors of consideration are the energy of the sensor network and the distance between the source and the sink node.

From the above related work, we can deduce that the existing routing protocols are using a single routing criteria for example some authors have considered the energy level only, while others have considered only the hop count. This type of approach can overload sensor nodes or drain energy in some nodes leading to unbalanced energy levels in the sensor nodes. Therefore, there is need to design a routing algorithm that is aware of the data congestion, the energy level and the distance for reliable and energy efficient communication of sensors for industrial applications. However other techniques for example Adaptive Neuro-Fuzzy Inference System (ANFIS) have not been considered because they are not search based and therefore they cannot be used alone to establish the shortest path between the source node and the sink node.

The proposed routing algorithm is modified to take extra considerations which include the data in the queue on the sensor nodes in addition to other considerations like the energy available in the node and the minimum distance between the start node and the sink node. The design uses FL and a heuristic search based algorithm ACO to enable efficient data transmission, utilize the energy in the network, extend the WSNs lifetime and hence increase their communication performance.

In this research ACO was chosen to perform routing optimization instead of other SI techniques such as cuckoo search, particle swarm Optimization (PSO), Genetic Algorithm (GA), Artificial Bee Colony (ABC) and other SI techniques. This is because ACO gives better performance, has faster convergence and can automatically adjust to an environment that dynamically changes over time [31]. Other authors who have used ant colony optimization alone for routing in wireless sensor networks are [32]. ACO together with the hybrid of FL is designed to take the extra important network considerations mentioned above.

CHAPTER THREE

RESEARCH METHODOLOGY AND DESIGN

3.1 Introduction

The aim of this research is to perform optimal routing for WSNs from source node to sink node. The developed algorithm has considered several parameters which include; the total energy of the sensor network, the distance and the data load in the queue. Due to the reason that WSNs are limited in energy the nodes need not to know about their geographic location if the routing protocol used is not location based. In this case the protocol is not location based and the sensor nodes do not know about the locality of the other nodes.

3.2 Research Design and Routing Model

The design used here is simulation research design in Matlab. The sensors have been randomly deployed and the routing protocol used is a hybrid of FACO for WSNs.

3.2.1 Fuzzy Logic

Figure 3.1 illustrates the FL system design. The network controller is the sink node. It is the one that sets up the routes for each sensor node, and also it acts as a gateway(destination) for WSNs to collect all the data from the network. The sink node is the one that evaluates the cost of each sensor node to the gateway and sets up the optimum route for each sensor node and broadcasts the route schedule to the sensor nodes.

FL system is a very important tool because we can incorporate the human way of reasoning to operate systems efficiently. This research has used FL to incorporate

important parameters that will determine the overall cost for a packet to be sent from source sensor node to the gateway. FL is used to evaluate the node cost with the input parameters being the energy of the sensor network and the data load in the queue.

ACO is very important search heuristic algorithm. It is in the class of SI and it is inspired by the process of ants searching the shortest paths between the nest and the food source. In this research ACO is used to calculate the shortest path that will be used after FL has calculated the node cost.

The sink node is the one using a Fuzzy Logic Controller (FLC) to determine the cost of each sensor node to reach the sink node. It queries all the sensor nodes to send the information about their energy status and the data status. The cost of the link is evaluated by the inputs of FLC being the transmission energy and the data. Once the cost of all the possible links to the sink node is computed the route will be determined using the shortest path algorithm for optimum route selection. This shortest path algorithm is ACO. Once the optimum path has been calculated the sink node is the one that broadcasts the routing schedule to each sensor node.

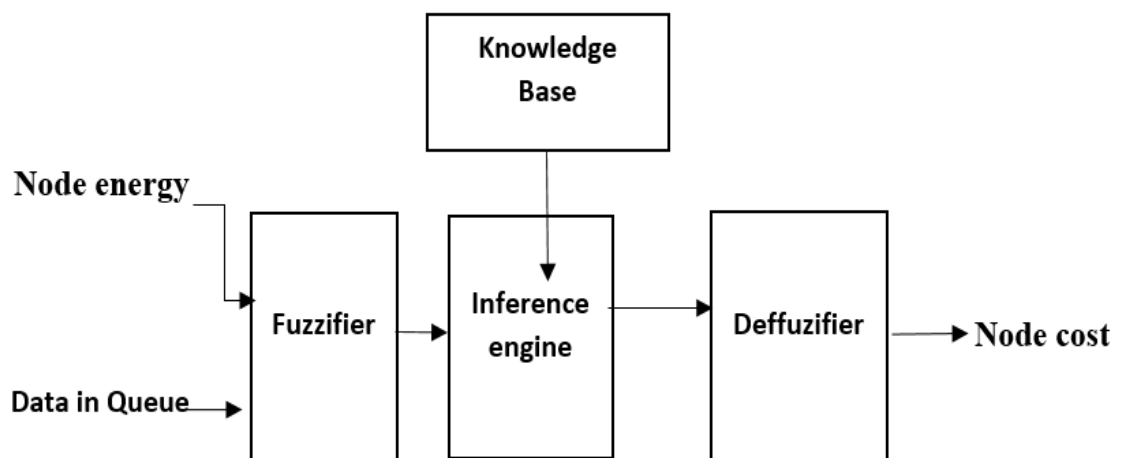

Figure 3.1 Fuzzy system for calculating the node cost

- **Fuzzifier**

Fuzzifier scales and maps input variables to fuzzy sets. It is the establishment of the fact base of the fuzzy system. It identifies the input and output of the system, defines appropriate IF THEN rules and uses raw data to derive a membership function. The engineer determines membership functions that map the crisp values of interest to fuzzy values [33].

- **Inference Engine**

Inference engine is used for approximate reasoning and it deduces the control action, evaluates all rules and determines their truth values. If an input does not precisely correspond to an IF THEN rule, partial matching of the input data is used to interpolate an answer [34].

- **Knowledge Base**

Knowledge base is the storage of all rules, the IF THEN rules. It assists the inference engine by providing the rules which determine the output of the FLC.

- **Defuzzifier**

Defuzzification is the process used to convert fuzzy output values to control signals. It involves conversion of the fuzzy value obtained from composition into a “crisp” value. It is necessary since controllers of physical systems require discrete signals [35]. Different methods of defuzzification can be used as which are as classified below [36] [37].

- a. **Centroid Method**

Often called Center of area or Center of gravity. The crisp value of the output variable is computed by finding the value of the center of gravity of the membership function for the fuzzy value.

The crisp value is calculated as follows;

$$\text{Output} = Z^* = \frac{\int \mu(z) * z \, dz}{\int \mu(z) \, dz} \quad (3.1)$$

Where \int denotes algebraic integration, Z^* is the defuzzified value, z indicates the sample element and $\mu(z)$ is the membership function.

b. Weighted Average Method

It is valid for symmetrical output membership functions. Formed by weighting each functions in the output by its respective maximum membership value.

This is done using the formula:

$$\text{Output} = Z^* = \frac{\sum \mu(z_{avg}) * z_{avg}}{\sum \mu(z_{avg})} \quad (3.2)$$

Where Z^* is the defuzzified value, Σ represents the algebraic summation, z_{avg} is the value with the maximum membership function and $\mu(z_{avg})$ is the membership function of the value with the maximum membership function.

c. Centre of Sums

It is Faster than many defuzzification methods. The formula used is

$$\text{Output} = Z^* = \frac{\int z^2 \sum \mu(z) \, dz}{\int z \sum \mu(z) \, dz} \quad (3.3)$$

Where Z^* is the defuzzified value, Σ represents the algebraic summation, $\mu(z)$ is the membership function and z indicates the sample element.

d. Max-membership Principal

Also known as height method. This defuzzification technique is very fast but is only accurate for peaked output. The output is equivalent to the maximum value at the peak point.

e. Mean-max Membership (middle of maxima)

Maximum membership is a plateau. The formula used is

$$\text{Output} = Z^* = (a + b)/2 \tag{3.4}$$

Where a is the value in the lower limit of the plateau, b is the value of the higher limit in the plateau and Z^* is the defuzzified value.

f. First (or Last) of Maxima

Determines the smallest value of the domain with maximized membership degree.

3.2.1.1 Description of inputs and output of the fuzzy system and their importance

Fuzzy inputs

a) Energy

The energy of WSNs is limited since these sensors rely on battery. To minimize energy consumption, this input is a variable that is used to determine the best node to be chosen in terms of the cost of the node. The energy limits are between 0 and 5 joules, with fuzzy variables low, medium and high. The energy model is based on first order radio model. The purpose of including first order radio model is to give priority to nodes with the highest energy. When a packet K is being transmitted from source node to destination

node through the selected nodes, energy is consumed and some of the nodes may be dead (may fail) depending on the number of simulated cycles.

b) Data

The number of packets K in the queue will determine how long it will take to empty the queue before a packet can be sent from source node to destination. In route selection the node with less data will have a high possibility of being picked because the data in the queue is minimized. The data limits are between 0 and 10 in bits with fuzzy variables low, medium and high.

Fuzzy output

Node cost

The output of the fuzzy system is the cost of each node. The node with the highest score will be selected, which is based on the highest energy and the least data. The cost limits are between 0 and 10. Once the nodes have been selected based on cost ACO is used to determine the optimum route to be used based on the shortest distance.

The limits of the FL system have been chosen based on the expert knowledge that, the nodes with the lowest data and highest energy will have the highest score and will be chosen to transmit or route data to the sink node.

3.2.2 Ant Colony Algorithm

ACO is very important search heuristic algorithm. It is in the class of SI and it is inspired by the process of ants searching the shortest paths between the nest and the food source [38] [39]. In this research ACO is used to calculate the shortest path that will be used after FL has calculated the node cost.

3.2.2.1 Description of ACO Algorithm for WSNs

Forward ants in creating solution: probabilistic process

Ants operate in two different ways either in forward or backward way. In forward direction, ants move from source node to destination node, while in backward direction ants are moving from destination node back to source node. For a given graph $G = (N, D)$, two sensor nodes $x, y \in N$ are neighbor's if there exists an arc $(x, y) \in D$.

The choice is probabilistically determined by the amount of pheromone trails that were deposited by other ants.

Backward ants in pheromone update: deterministic process

The backward ant retraces the route it followed when finding the destination node. The backward ant leaves pheromone on the arcs they pass through while moving in the backward direction.

Pheromone updates in relation to the quality of the solution

Ant colonies are intelligent as they know the nodes they had visited in the forward direction and also the cost of the arcs traversed. The cost determines the amount of pheromone they deposit while in the backward mode. More pheromone is deposited on short paths.

Pheromone evaporation

For a period of time the amount of pheromone that was deposited reduces because of the effect of evaporation. The purpose of pheromone evaporation is to decrease the effect of the amount of pheromone that was deposited in the initial stages of path finding.

The pheromone trail is defined by τ_{xy} .

When the search process starts every arc is assigned a specific amount of pheromone. For a source node x , an ant m uses the pheromone trails τ_{xy} to evaluate the probability of choosing y as next node.

$$p_{xy}^m = \begin{cases} \frac{\tau_{xy}^\alpha}{\sum_{l \in N_x^m} \tau_{xl}^\alpha} & \text{if } x \in N_y^m \\ 0 & \text{otherwise} \end{cases} \quad (3.5)$$

Where N_x^m is the neighborhood of ant m when in node x . Equation (3.5) shows the probability of an ant m moving from source node x to other nodes until it reaches the destination node. In route searching every ant m takes different routes and so the ant with the least path will arrive at the destination node faster.

Once an ant reaches the destination, it changes from forward direction movement to backward direction movement. During the backward trip an ant m will deposit an amount of Δ_T^m of pheromone on arcs visited. If ant m is in the arc (x,y) the pheromone value changes to τ'_{xy} as shown

$$\tau'_{xy} = \tau_{xy} + \Delta_T^m \quad (3.6)$$

From equation (3.6) an ant using the arc connecting node x to node y increases the probability that the other ants will use the same arc. For ants using the shorter route they will take shorter time and hence more pheromone will be deposited in shorter routes. The importance of having pheromone evaporation is to discourage ants from converging in routes which are sub-optimal. The speed of pheromone trails evaporation is exponential and its done by using the following equation in all arcs.

$$\tau_{xy} \leftarrow (1-e) \tau'_{xy}, \quad \forall (x, y) \in D \quad (3.7)$$

where e (0, 1) is the pheromone evaporation coefficient.

The amount of pheromone Δ_t^k is added to the arcs after equation (3.7) is used on all the arcs. ACO is achieved with the cycle of ant's movement, pheromone evaporation and pheromone deposit until an optimum path is located. Ant colony optimization algorithm will converge for increasing number of cycles until the point where the ant's probability of using the arcs of a certain route is acquired defining the optimum route [40] [41].

3.3 Data Collection Procedure

The simulation has been carried out in Matlab C code. Figure 3.2 shows the flow chart diagram, the procedure is to generate a WSN scenario first, the sensor nodes are randomly deployed in the target area. Secondly, the FL is used to calculate the node cost for each sensor node with the inputs being the data and the energy of the nodes. Thirdly a source node has been chosen as well as a sink node. Finally, ACO is used to search and plot the shortest path between the source node and the sink node. The parameters are evaluated to determine WSNs performance in relation to energy level in the node, the number of dead nodes and success rate of packet delivery to the sink node.

3.3.1 Routing Algorithm

//WSNs deployment

Begin

 Initialize

 field dimensions' x and y maximum in meters

 the x and y coordinate of the sink node

 the number of nodes in the network

End

//WSNs initialization

□ edges $D \in G(N,D)$

Assign the initial energy to each node

Initialize the transmission distance between two sensor nodes.

Assign the amplification coefficient that allows minimum bit error rate.

Calculate the amount of dissipated energy to operate the transceiver.

//Fuzzy logic

Assign membership function values to each node for each input parameter and the output

Compute the cost of each node to the sink node based on energy used and the data

//Route finding

Begin

 Initialize ant's information

 Number of ants k

 Evaporation coefficient(e)

 Number of cycles

 Effects of ant's sight (α)

 Traces effect(β)

 While stopping criteria not satisfied do

 Set each ant at the source node

 Repeat

 For each ant do

 Apply probability rule

 Move to choose the next node

 Apply pheromone update

 End for

 Until every ant has built a solution

 Locally optimize the solution

Find best solution
Update global pheromone
Output optimum route

End while

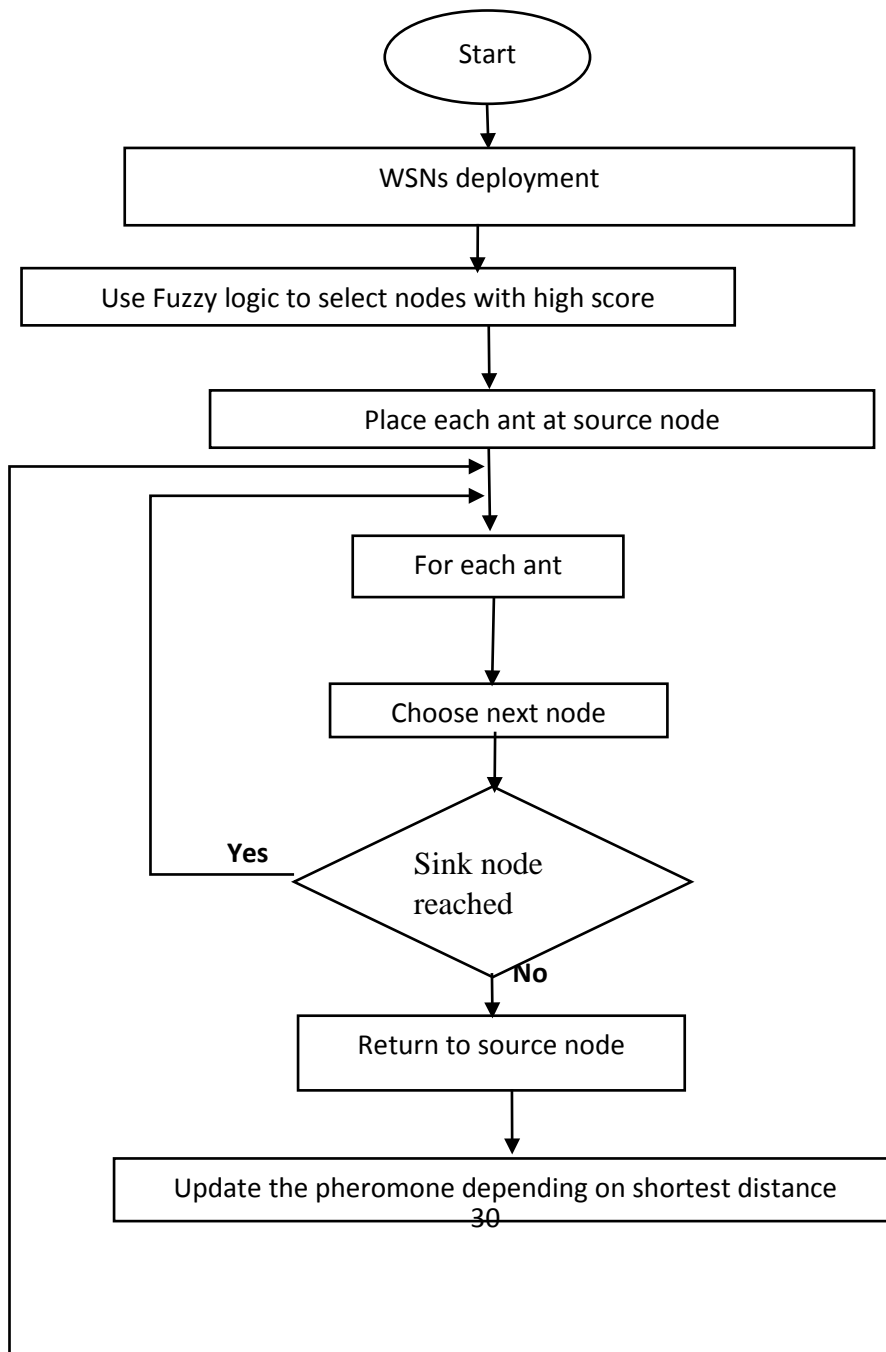

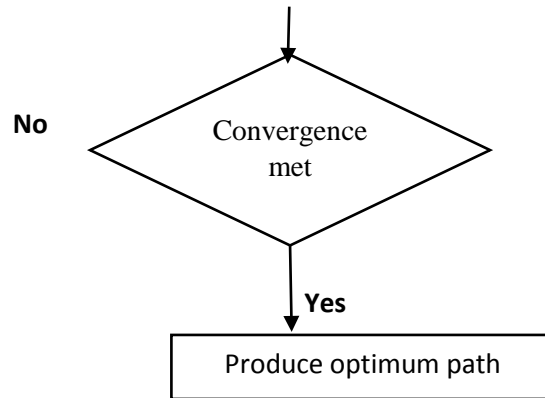

Figure 3.2 System architecture

CHAPTER FOUR

RESULTS AND DISCUSSIONS

4.1 Routing Model for WSN

The first objective was to develop a routing model for WSNs. This model was used in the simulation to perform routing optimization for WSNs. The developed routing model is energy aware, distance aware and data aware. This model proved to be effective and reliable in terms of energy level, number of dead nodes and packet delivery. The cost of sensor nodes was calculated using FL. The nodes with the highest score were used for selection of the best route using ACO.

Figure 4.1 describes the routing model for WSNs, it illustrates results and observations obtained from the first objective.

- Wireless sensors were randomly deployed in the desired region. For industrial applications the sensors are deployed in the target area for example in power transformer to measure temperature, humidity and oil level for transformer protection.

- The cost of each node to the sink was evaluated using FL. Every sensor node sends its details to the sink node where the cost is calculated. The parameter values sent to the sink node are the energy of each node in joules and the amount of data in the queue. The energy was calculated using first order radio model for WSNs.
- The sensor node with the highest score was considered for routing. The node with the highest energy and the least data in the queue has the highest score. The highest score in this research work refers to the good nodes, nodes with a lower score are referred to as bad nodes and were not considered for routing until the next cycle.
- Several nodes with high score were selected for routing. Once the nodes were selected for routing, ACO evaluated the optimum path to the sink node based on the shortest path. ACO evaluated the shortest path by applying more pheromone trails along the arcs with the highest score (good nodes) as well as pheromone evaporation to clear trails in the least score paths (bad nodes). The shortest path with the minimum distance was established in the good nodes.
- The sink node acted as the gateway where information or packets were delivered. For industrial application in the case of power transformer monitoring, if the temperature exceeds the set limits or the oil level is below the minimum value, various control measures will be set based on the information sent to the sink node.

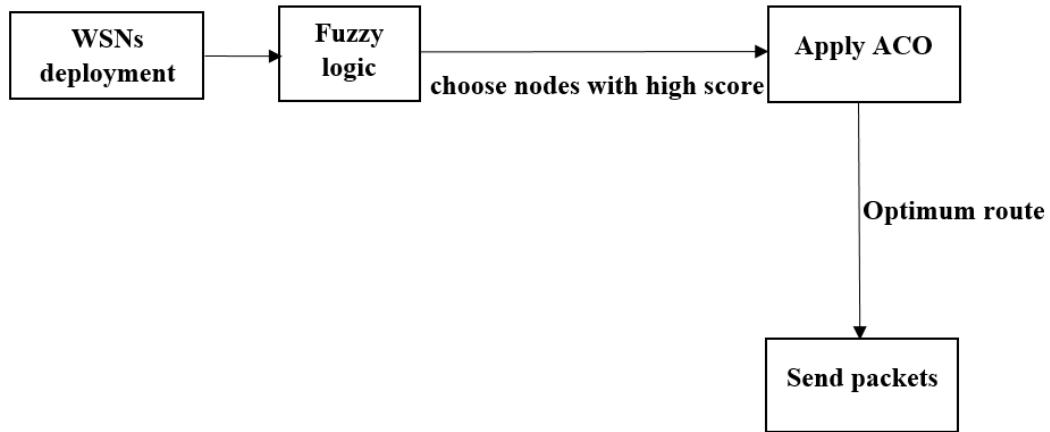

Figure 4.1 Routing model for WSNs

4.2 Simulation of Model in Matlab C code using Ant Colony and Fuzzy Logic

Table 4.1 displays the simulation parameters which are the same as the parameters chosen for the author in reference [29] who used ACO to perform routing for WSNs. This research has combined a hybrid method of FACO. The parameters were chosen to enable comparison of the two techniques FACO and ACO and to measure the performance of the proposed technique.

Table 4.1 Simulation parameters

Parameters	Value
X*Y simulation area	100*100 m ²
Number of nodes (N)	100
Sink node location	50*175 m ²
Node initial energy	5 joules
Number of Maximum data load	10 bits
Packet length	6400 bits
Distance between nodes (d)	50 meters
ϵ_{amp}	50 nJ/bits

E_{e_tx}	100pJ/bits/m ²
-------------	---------------------------

Figure 4.2 illustrates how the sensors have been randomly deployed within an area of 100*100 m², with the sink node located at position (50,175) m². The model utilizes the first order radio model as discussed in [6]. In this radio model the amount of dissipated energy to operate the transmitter is E_{e_tx} which has been initialized to 100 pJ/bits/m² in this simulation. The amplification coefficient that enables minimum bit error rate ϵ_{amp} has been initialized to 50 nJ/bits. The data load is between 0 and 10 with a packet size of 6400 bits. The distance between two sensor nodes d is simulated as 50 meters. The simulation values are the same as for the author in reference [29] for the purpose of comparing the results to evaluate the performance of the developed routing algorithm.

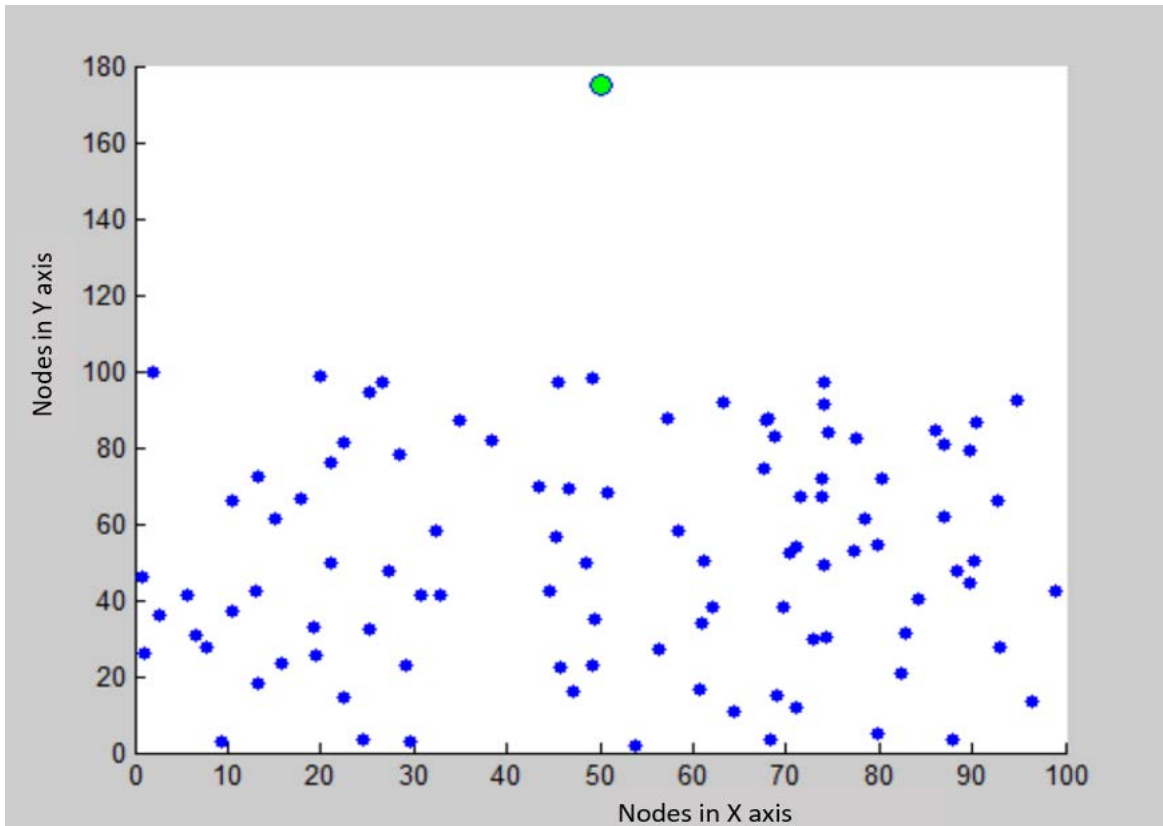

Figure 4.2 WSNs deployment

4.2.1 Simulation Output

4.2.1.1 Implementation of Fuzzy Logic

The fuzzy regions

Two parameters (energy of a sensor node and the amount of data in the queue) determine the cost of a sensor node. The fuzzy terms for energy have been defined as Low (LW), Medium(MW) and High (HG) measured in joules in the range of 0 to 5. The fuzzy terms for data load in the queue are defined as Low (LW), Medium(MW) and High (HG) measured in bits in the range of 0 to 10. The fuzzy terms for cost output of the sensor nodes are defined as Small (SM), Medium(MW) and Large (LG) measured in the range of 0 to 10.

Figure 4.3 demonstrates the membership functions used for energy input which are triangular and trapezoidal. The linguistic variables Low and High have used trapezoidal membership functions, while medium has used triangular membership function. The membership functions triangular and trapezoidal are used because they have simple formulas which make them easy to use and also they have a high computational efficiency as compared to other membership functions For energy input three fuzzy states have been used: Low (LW), Medium(MW) and High (HG). Their memberships are defined in the support set [0, 5]. The membership functions are defined below as per the fuzzy region;

$$\mu_{LW} = \begin{cases} 1.0 & \text{for Energy} = [0 J, 0.7 J] \\ \text{linear} [1.0, 0] & \text{for Energy} = [0.7 J, 2 J] \\ 0 & \text{for Energy} = [2 J, 5 J] \end{cases}$$

$$\mu_{MD} = \begin{cases} 0 & \text{for Energy} = [0, 0.5] \\ \text{linear}[0, 1.0] & \text{for Energy} = [0.5, 2.5] \\ \text{linear}[1.0, 0] & \text{for Energy} = [2.5, 4.5] \\ 0 & \text{for Energy} = [4.5, 5] \end{cases}$$

$$\mu_{HG} = \begin{cases} 0 & \text{for Energy} = [0, 3.5] \\ \text{linear}[0, 1.0] & \text{for Energy} = [3.5, 4.5] \\ 1 & \text{for Energy} = [4.5, 5] \end{cases}$$

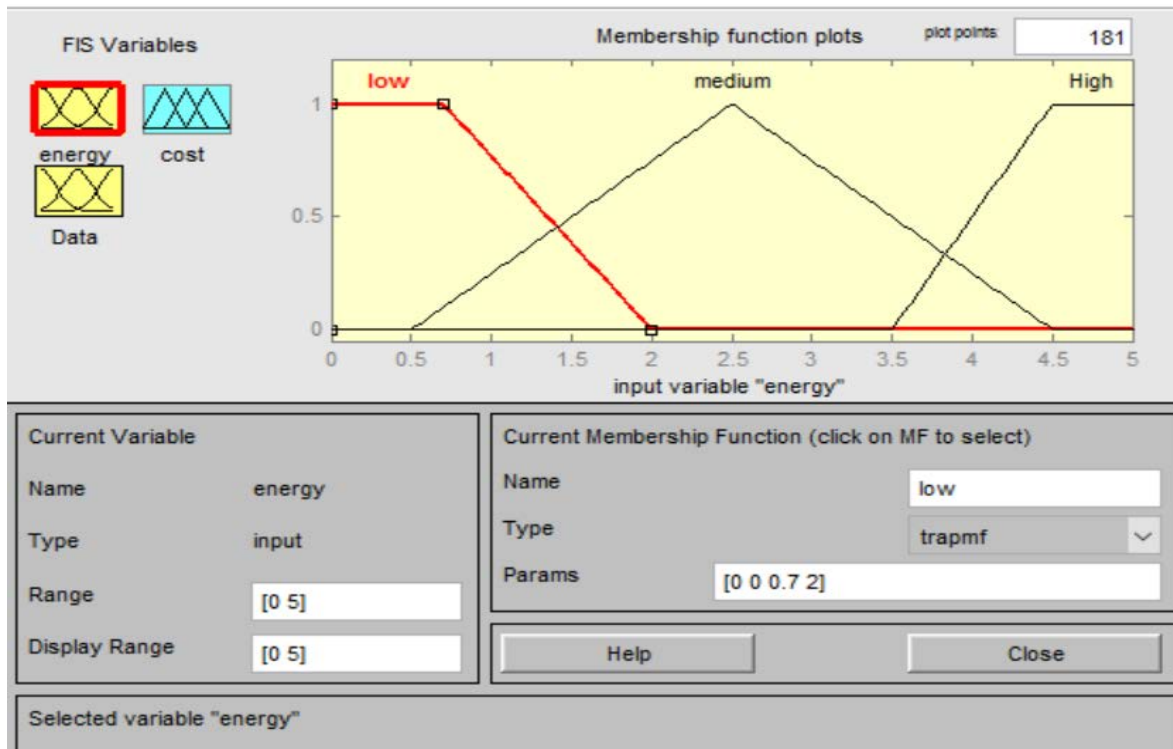

Figure 4.3 Membership function for energy input of sensor node

Figure 4.4 shows the membership functions used for data input which are triangular and trapezoidal. The linguistic variables Low and High have used trapezoidal membership functions while medium has used triangular membership function. The membership functions triangular and trapezoidal are used because they have simple formulas which make them easy to use and also they have a high computational efficiency as compared to other membership functions. For data input three fuzzy states have been used: Low

(LW) , Medium(MW) and High (HG). Their memberships are defined in the support set [0, 10]. The membership functions are defined below as per the fuzzy region;

$$\mu_{LW} = \begin{cases} 1.0 & \text{for Traffic} = [0E, 2E] \\ \text{linear} [1.0, 0] & \text{for Traffic} = [2E, 5E] \\ 0 & \text{for Traffic} = [5E, 10E] \end{cases}$$

$$\mu_{MD} = \begin{cases} 0 & \text{for Traffic} = [0E, 3E] \\ \text{linear} [0, 1.0] & \text{for Traffic} = [3E, 5E] \\ \text{linear} [1.0, 0] & \text{for Traffic} = [5E, 8E] \\ 0 & \text{for Traffic} = [8E, 10E] \end{cases}$$

$$\mu_{HG} = \begin{cases} 0 & \text{for Traffic} = [0E, 6.5E] \\ \text{linear} [0, 1.0] & \text{for Traffic} = [6.5E, 8.5E] \\ 1 & \text{for Traffic} = [8.5E, 10E] \end{cases}$$

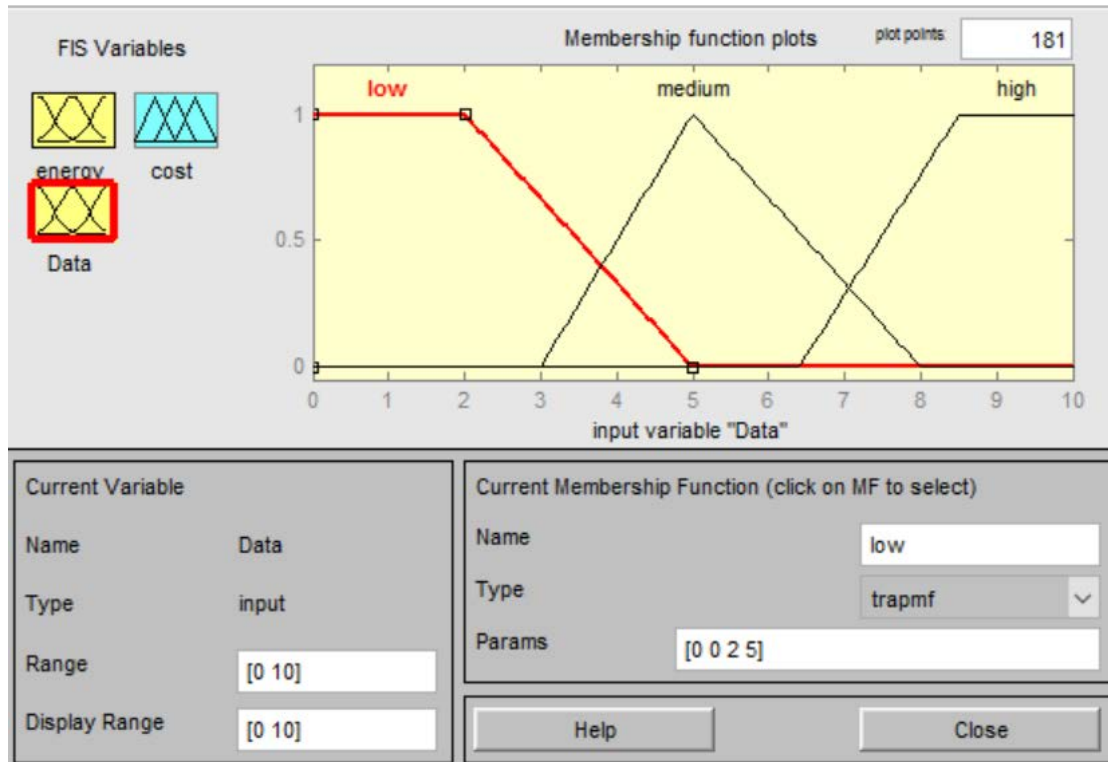

Figure 4.4 Membership function for data input

Figure 4.5 shows the membership functions used for node cost output which are triangular and trapezoidal. The linguistic variables Small, Medium and Large have used trapezoidal membership functions while Very small and Very Large have used triangular

membership function. The membership functions triangular and trapezoidal are used because they have simple formulas which make them easy to use and also they have a high computational efficiency as compared to other membership functions. For cost output five fuzzy states have been used: Very small (VS), Small(SM), Medium(MW), Large(LG) and Very Large (VL). Their memberships are defined in the support set [0, 10].

$$\mu_{VS} = \begin{cases} 1.0 & \text{for Cost} = [0, 0.2] \\ \text{linear}[1.0, 0] & \text{for Cost} = [0.2, 2.2] \\ 0 & \text{for Cost} = [2.2, 10] \end{cases}$$

$$\mu_{SM} = \begin{cases} \text{linear}[0, 1.0] & \text{for Cost} = [0, 2.5] \\ \text{linear}[1.0, 0] & \text{for Cost} = [2.5, 5] \\ 0 & \text{for Cost} = [5, 10] \end{cases}$$

$$\mu_{MD} = \begin{cases} 0 & \text{for Cost} = [0, 2.5] \\ \text{linear}[0, 1.0] & \text{for Cost} = [2.5, 5] \\ \text{linear}[1.0, 0] & \text{for Cost} = [5, 7.5] \\ 0 & \text{for Cost} = [7.5, 10] \end{cases}$$

$$\mu_{LG} = \begin{cases} 0 & \text{for Cost} = [0, 5] \\ \text{linear}[0, 1.0] & \text{for Cost} = [5, 7.5] \\ \text{linear}[1.0, 0] & \text{for Cost} = [7.5, 10] \end{cases}$$

$$\mu_{VL} = \begin{cases} 0 & \text{for Cost} = [0, 7.8] \\ \text{linear}[0, 1.0] & \text{for Cost} = [7.8, 9.8] \\ 1 & \text{for Cost} = [9.8, 10] \end{cases}$$

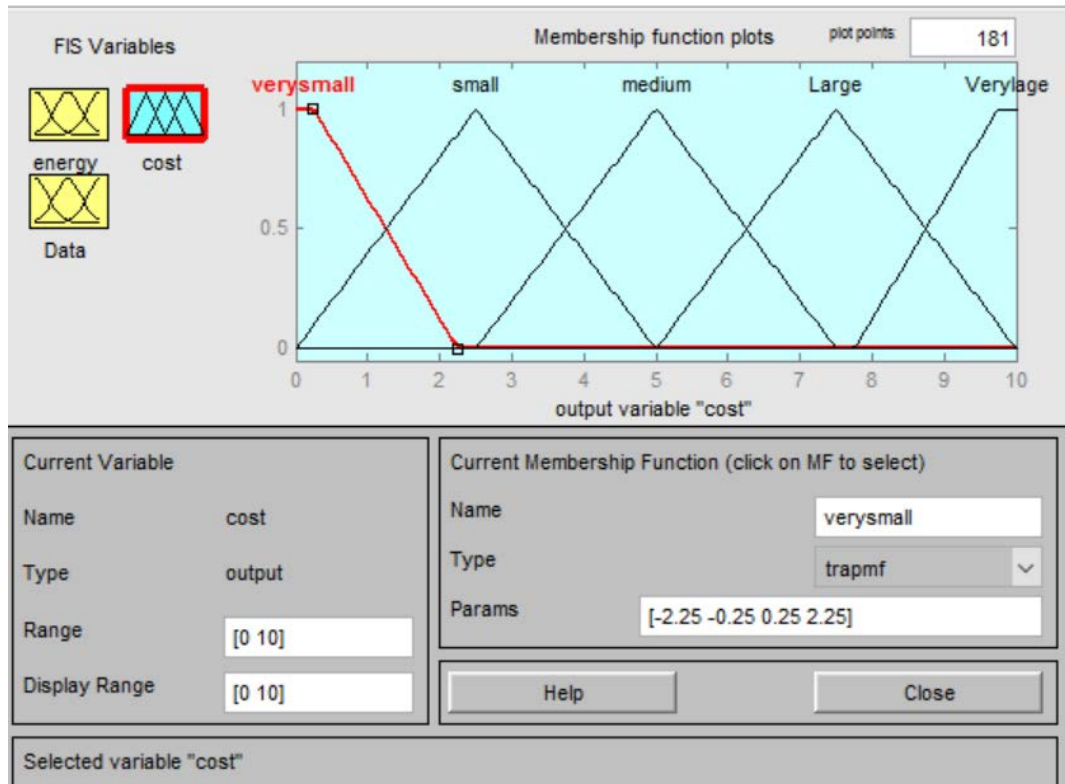

Figure 4.5 Membership function for node cost output

Fuzzy rules

The fuzzy rules form the knowledge base for inference engine. The fuzzy rules maybe formed among the following statements.

- Assignment statements

They are used to restrict the value of a variable to a specific quantity. For example energy is Low(LW).

- Conditional statements

They form both the assignment statement and the consequent statement, with IfThen statements. For example, IF energy is Low and data is Low THEN the node cost is Medium

- Unconditional statements

These statements exclude the IF clause for example turn the pressure lower.

The statements used in this simulation are conditional statements because they are the most appropriate statements for fuzzy reasoning.

Table 4.2 and Figure 4.6 illustrates the fuzzy rules used to assist the inference engine to perform deductive reasoning. The Rules are nine and are IF... THEN rules.

- If energy is low and data low, then the cost is medium.
- If energy is medium and data is low, then cost is large.
- If energy is high and data is low, then cost is large.
- If energy is low and data is medium, then cost is small.
- If energy is medium and data is medium, then cost is medium.
- If energy is high and data is medium, then cost is large.
- If energy is low and data is high, then cost is small.
- If energy is medium and data is high, then cost is small.
- If energy is high and data is high, then cost is medium.

Table 4.2 Fuzzy rules in tabular form

Energy	Data	Node cost
low	low	medium
medium	low	large
high	low	very large
Low	medium	small
medium	medium	medium
High	medium	large
low	high	very small
medium	high	small
high	high	medium

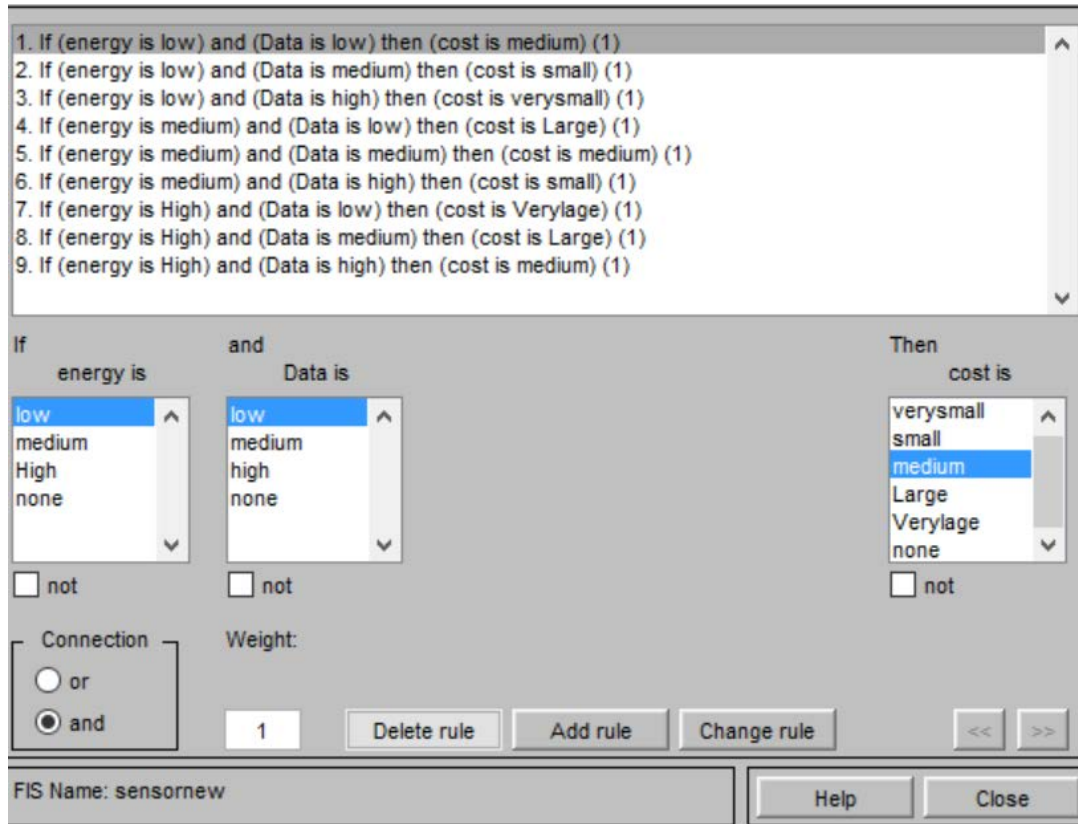

Figure 4.6 Fuzzy rules

Fuzzification

The fuzzifier is the brain of the fuzzy engine it does approximate reasoning in order to come up with a decision. When a wireless sensor sends values of energy and data to the sink node they are mapped based on their membership functions to their respective fuzzy regions that they belong to. For example, when energy is at 1.5 joules and data is at 7 bits their corresponding membership values and associated fuzzy regions are as shown in Table 4.3.

Table 4.3 Fuzzification representation

Parameter	Fuzzy region	Membership function
Energy	Low(LW), Medium(MD)	0.3, 0.4
Data	Medium(MD), High(HG)	0.2, 0.1

Defuzzification

In defuzzification process we want to convert the fuzzy outputs Small(SM), Medium(MD) and Large(LG) to a single crisp value which is to be used to choose the best sensor node. The commonly used defuzzification method is centroid and is applied in this simulation because it is easier to use and accurate as compared with other methods.

Figure 4.7 demonstrates the centroid method of defuzzification is used to evaluate the crisp value of cost. For example given energy= 2.59 J; data = 4.59 bits then the crisp value for cost = 5.45 from Matlab in Figure 4.7. The input values energy= 2.59 J; data = 4.59 are used below to calculate the crisp value of cost as the output manually using the formula for centroid method of defuzzification, the values of membership function $\mu(z)$ listed in equation 4.1 below and their respective elements z have being obtained from Figure 4.7.

$$\mu(z) = \begin{cases} 0 & 0 \leq z < 3 \\ z - 3 & 3 \leq z < 4 \\ 1 & 4 \leq z < 6 \\ 0.8z - 3.8 & 6 \leq z < 7 \\ 0.2 & 7 \leq z < 10 \end{cases}$$

(4.1)

$$\text{Cost} \quad \text{output} = Z^* = \frac{\int \mu(z) * z \, dz}{\int \mu(z) \, dz} = \frac{\text{Num}}{\text{Den}}$$

(4.2)

$$Num = \int \mu(z) * z dz$$

$$= \int_3^4 (z - 3)z dz + \int_4^6 z dz + \int_6^7 (0.8z - 3.8)z dz + \int_7^{10} 0.2z dz$$

$$= \int_3^4 (z^2 - 3z) dz + \int_4^6 z dz + \int_6^7 (0.8z^2 - 3.8z) dz + \int_7^{10} 0.2z dz$$

$$= \left[\frac{z^3}{3} - \frac{3z^2}{2} \right]_3^4 + \left[\frac{z^2}{2} \right]_4^6 + \left[\frac{0.8z^3}{3} - \frac{3.8z^2}{2} \right]_6^7 + \left[\frac{0.2z^2}{2} \right]_7^{10}$$

$$= \left\{ \left(\frac{64}{3} - \frac{48}{2} \right) - \left(9 - \frac{27}{2} \right) \right\} + \{18 - 8\} + \left\{ \left(\frac{91.5}{3} - \frac{93.1}{2} \right) - \left(\frac{57.6}{3} - \frac{68.4}{2} \right) \right\} +$$

$$\{10 - 4.9\}$$

$$= 26.133$$

$$Den = \int \mu(z) dz$$

$$= \int_3^4 (z - 3) dz + \int_4^6 dz + \int_6^7 (0.8z - 3.8) dz + \int_7^{10} 0.2 dz$$

$$= \left[\frac{z^2}{2} - 3z \right]_3^4 + \left[z \right]_4^6 + \left[\frac{0.8z^2}{2} - 3.8z \right]_6^7 + \left[0.2z \right]_7^{10}$$

$$= \left\{ \left(8 - 12 \right) - \left(\frac{9}{2} - 9 \right) \right\} + 2 + \left\{ \left(\frac{98}{5} - 26.6 \right) - \left(\frac{72}{5} - 22.8 \right) \right\} + \{2 - 1.4\}$$

$$= 4.5$$

$$\text{Cost output} = Z^* = \frac{\int \mu(z) * z dz}{\int \mu(z) dz} = \frac{Num}{Den} = \frac{26.133}{4.5} = 5.807$$

The calculated value is close to the Matlab value for the cost output, calculated value is 5.807 and Matlab value is 5.45, the calculated value has an error of 0.357 because of truncating during calculation.

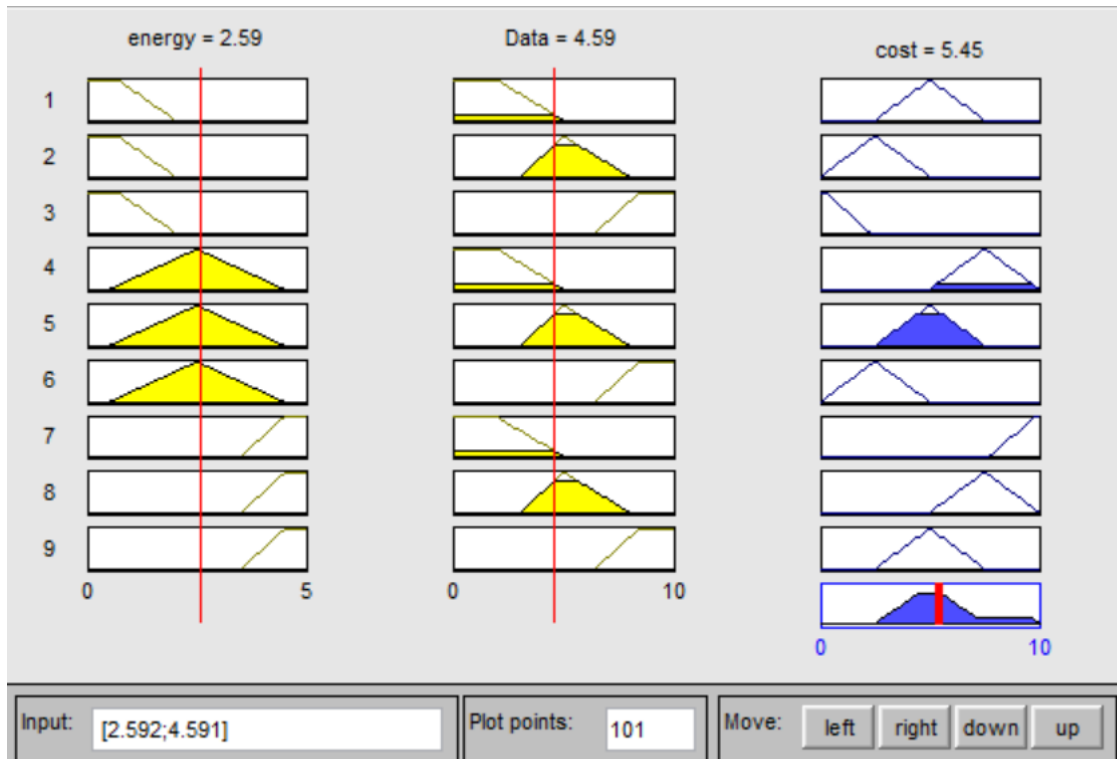

Figure 4.7 Fuzzy rule viewer

Figure 4.8 illustrates the surface viewer showing the dependence between the inputs (energy and data) and the output (cost). The node with the highest energy and the least data in the queue has the highest score. The highest score in this research work refers to the good nodes, nodes with a lower score are referred to as bad nodes and will not be chosen for routing. The good nodes are chosen for routing in WSNs.

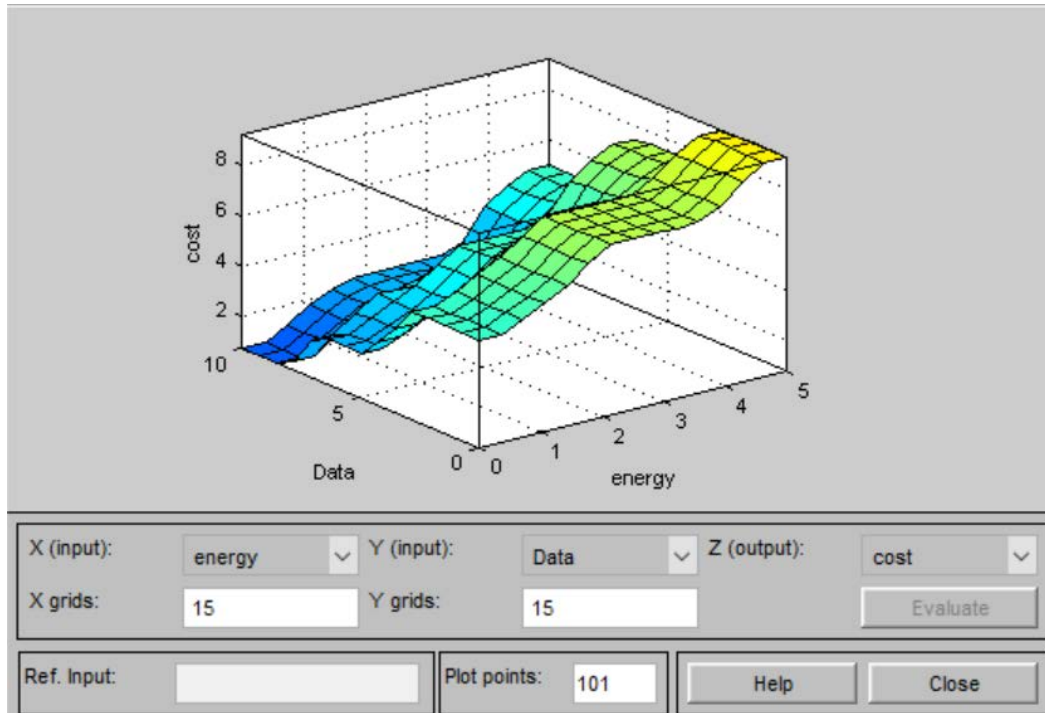

Figure 4.8 Surface viewer for fuzzy system

4.2.1.2 Implementation of Ant Colony Algorithm

ACO computes the optimum shortest route from source node to the sink node. The procedure is to initialize the coefficients for ant algorithm, these coefficients are given in Table 4.4.

Table 4.4 Ant colony parameter initialization

Parameter	Value
Number of ants (m)	100
Evaporation coefficient(e)	0.1
Number of cycles	50
Effects of ants sight (α)	1
Traces effect(β)	5

After parameter initialization the ants are placed at the initial sensor node where they move through neighboring nodes to the sink node while searching for the shortest route.

Figure 4.9 displays a plot of the energy level in the sensor node during data transmission at different cycles for FACO. WSNs have a radio that is turned on during transmission

and switched off when the node is in sleep mode. For simulation a first order radio model is used and an initial energy of 50 joules is assigned to each node. Both the transmitter energy E_{e_tx} and receiver energy E_{e_rx} contribute to the amount of energy that remains in the node after data transmission. The energy level has dropped from 50 Joules to 5 Joules in 600 cycles exponentially. For more cycles more nodes will fail since most of the energy will be consumed when information is sent from source node to the sink node.

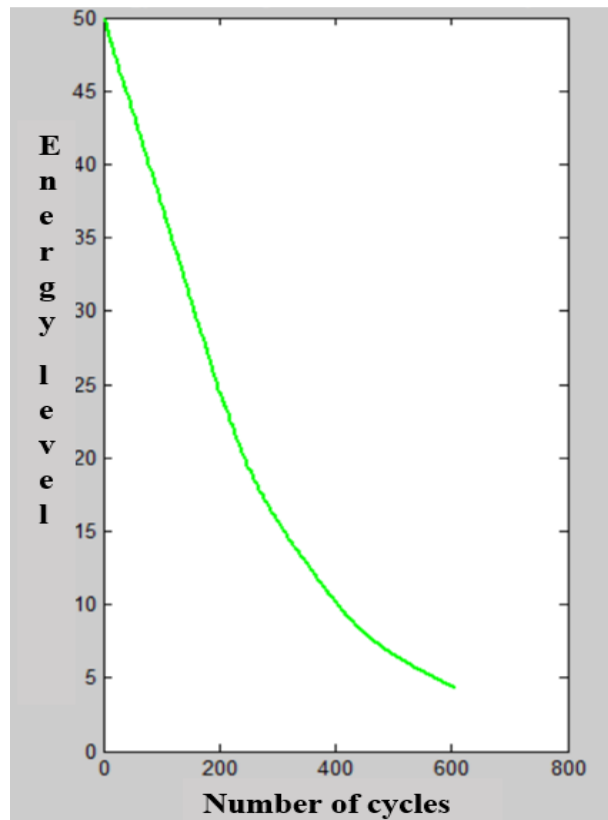

Figure 4.9 Energy level versus number of cycles

Figure 4.10 illustrates the number of successful packets delivered to the sink node in 600 cycles for FACO. The number of packets are increasing exponentially. When a node wants to send information a signal is sent to the sink node to request for the route. The

sink node evaluates the optimum route and sends the routing table to the node by sending an acknowledgement signal. If a packet is not delivered to the sink node the source node will try to retransmit a few times before it stops. The packets delivered successfully to the sink node are counted for different cycles.

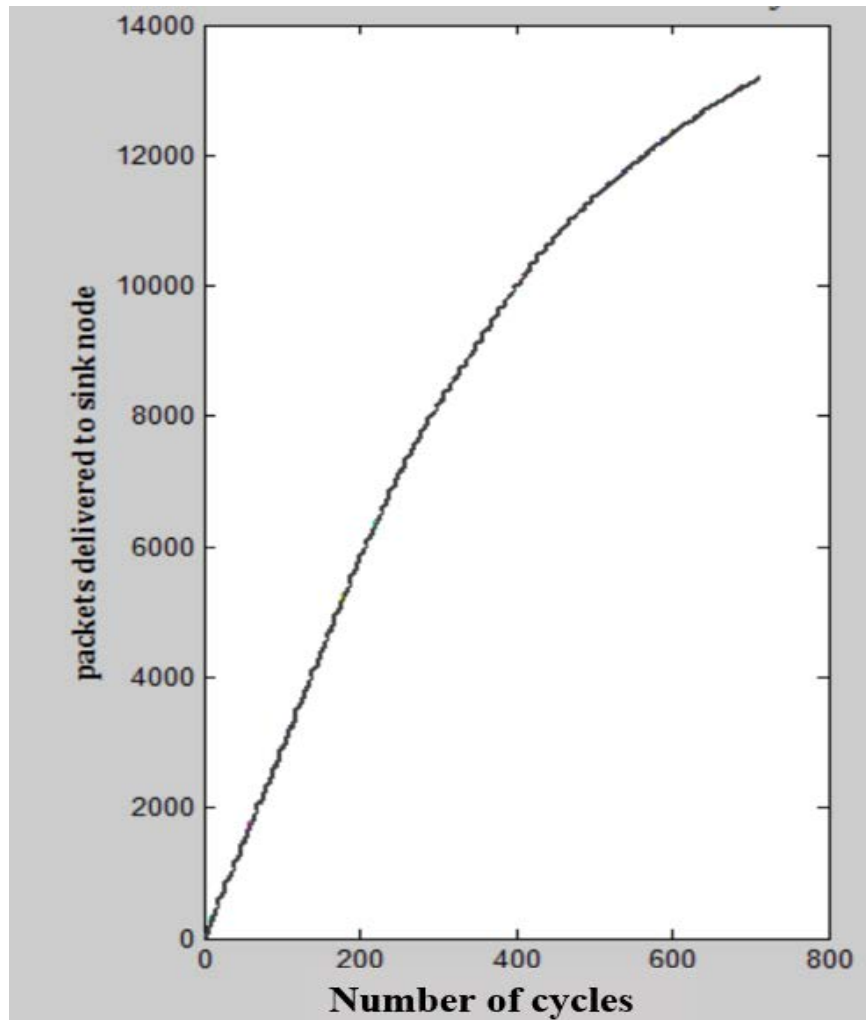

Figure 4.10 Packets delivered to sink node versus number of cycles

Figure 4.11 shows the number of dead nodes in relation to the number of cycles for FACO. In this case we have 400 cycles because if we have 800 cycles all 100 nodes will fail (have zero energy) because their energy will be fully used up for data transmission.

A node is considered to be dead if the amount of energy is depleted and it cannot participate in data transmission. During the entire process of data transmission some nodes will be depleted of energy. For a period of less than 180 cycles all nodes are available for data transmission. For the period after 180 cycles a number of nodes are not available for data transmission. If the cycles are many more nodes will be dead and hence not available for sending information.

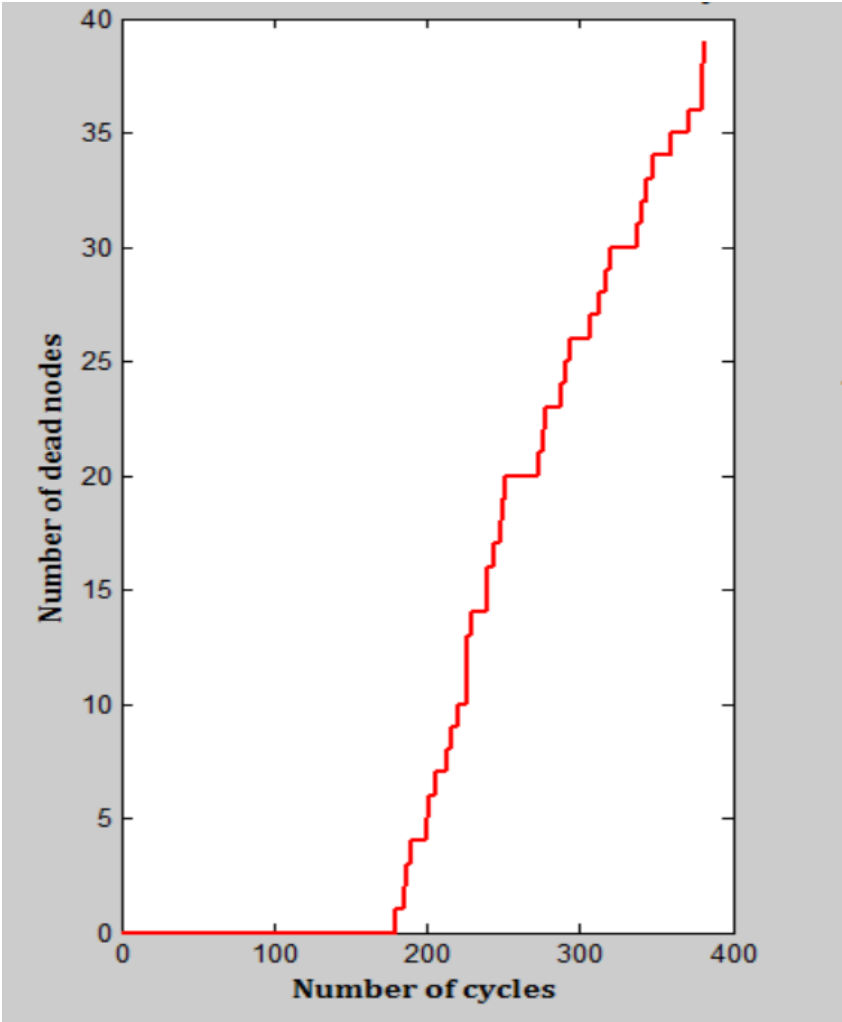

Figure 4.11 Number of dead nodes versus number of cycles

4.3 Performance Comparison of Designed Routing Algorithm with Existing Technique

The designed routing technique is a hybrid of fuzzy logic and ant colony optimization algorithm. The performance of this technique was compared to the performance when using ACO routing algorithm alone, this is with reference to [29] which used ACO algorithm alone to perform routing in WSNs. The performance has been enhanced by adding FL to ACO to evaluate the cost of each node, choose the nodes with the highest energy (good nodes) by ignoring nodes with the lowest energy (bad nodes) and establishing the shortest route within the good nodes. The simulation parameters are the same as for the author in reference [29].

Figure 4.12 illustrates the performance of FACO as compared to the performance of ACO. The number of packets delivered to the sink node are higher for FACO routing technique as compared to ACO. This is because FACO includes many parameters that affect the battery lifetime of WSNs. FACO has taken into account the amount of energy level in the node, the amount of data in the queue and the distance from source node to the sink node. ACO routing algorithm only evaluates the shortest distance from source node to the sink node and hence the number of packets delivered was lower since the path with the highest data load in the queue but shortest distance may have been followed leading to delay in the number of packets delivered. At cycle 50 the number of packets delivered to the sink node are 201 for FACO and 170 for ACO. From equation (4.3), there is an increase of 18.24 % in the number of packets delivered to the sink node for FACO as compared to ACO routing protocol.

$$P_{inc} = \frac{P_{FACO} - P_{ACO}}{P_{ACO}} * 100 \%$$

(4.3)

$$P_{inc} = \frac{201 - 170}{170} * 100 \% = 18.24 \%$$

Where P_{inc} is the percentage increase in the number of packets delivered to the sink node, P_{FACO} is the number of packets delivered for FACO and P_{ACO} is the number of packets delivered for ACO.

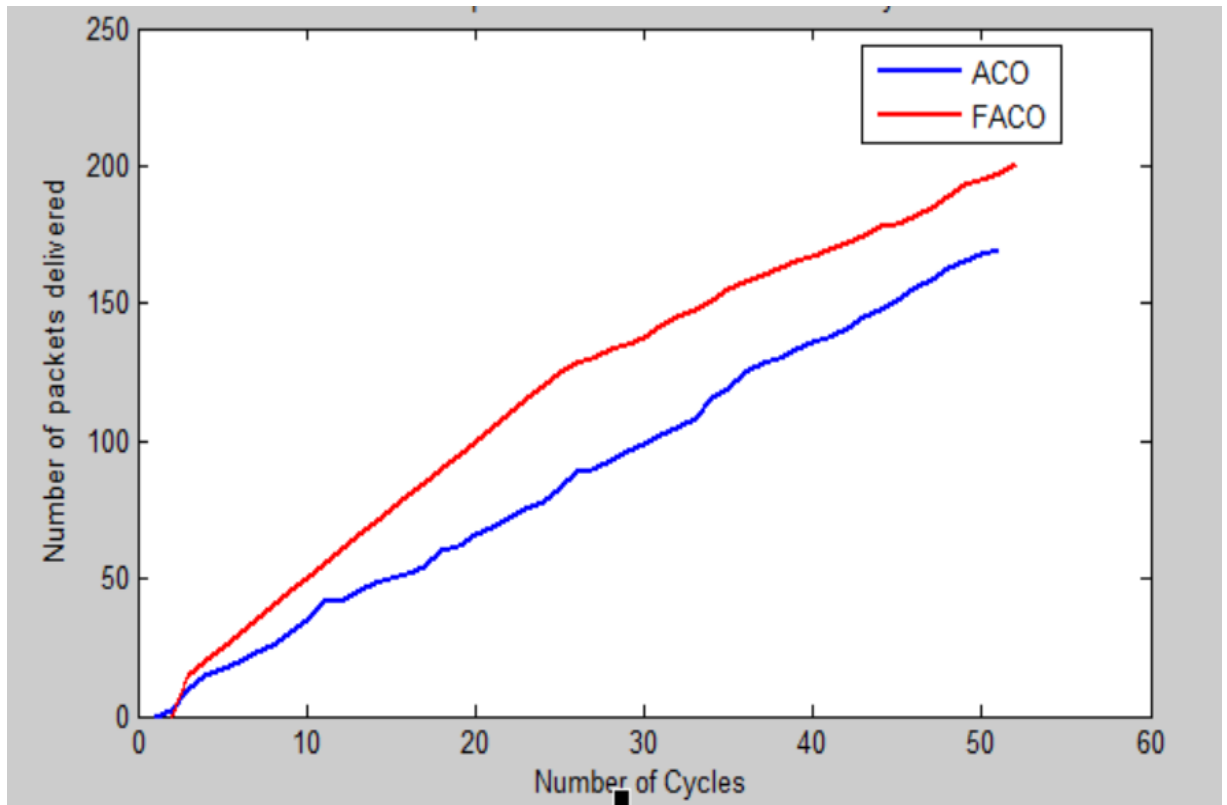

Figure 4.12 Performance of FACO compared to ACO for packet delivery

Figure 4.13 demonstrate the performance of FACO as compared to the performance of ACO. The number of dead nodes are higher for ACO routing technique as compared to FACO technique. A node is considered to be dead if the energy level is zero and is

unavailable for data transmission. This criterion of assessing the number of dead nodes is used in order to evaluate the number of sensor nodes available for data transmission. The more the number of nodes available for transmission the better the routing protocol. The figure shows that more nodes are failing (with zero energy level) as the number of cycles increase for ACO because the algorithm is not energy aware and data aware. At cycle 50 the number of dead nodes for ACO is 45 and the number of dead nodes for FACO is 27. From equation (4.4), there is a 40% decrease in the number of dead nodes when using FACO routing algorithm as compared to when using the ACO routing technique. This shows an improved performance for the proposed routing algorithm because FACO protocol has more nodes available for data transmission as compared to ACO.

$$N_{dead} = \frac{N_{deadACO} - N_{deadFACO}}{N_{deadACO}} * 100 \% \quad (4.4)$$

$$N_{dead} = \frac{45 - 27}{45} * 100 \% = 40 \%$$

Where N_{dead} is the percentage number of dead nodes, $N_{deadFACO}$ is the number of dead nodes for FACO and $N_{deadACO}$ is the number of dead nodes for ACO.

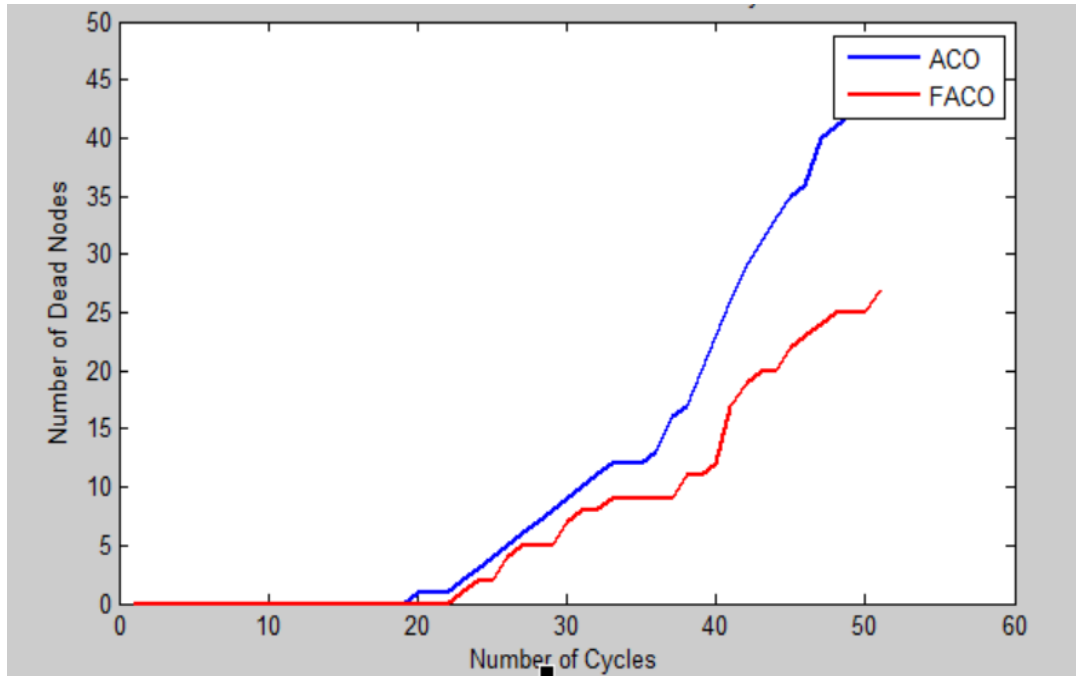

Figure 4.13 Performance of FACO compared to ACO for number of dead nodes

Figure 4.14 illustrates the performance of FACO as compared to the performance of ACO for 51 cycles. For nodes using FACO protocol the energy consumed is at a lower rate as compared to ACO for the same iterations. The figure shows that FACO is more energy efficient as compared to ACO. At cycle 20, the amount of energy level in the node for ACO is 1.4 joules while the amount of energy level in the node when using FACO technique is 2.8 joules. From equation (4.5), there is 100% increase in the energy level conserved in a sensor node. More energy is conserved in FACO because the protocol is energy aware unlike ACO protocol which is not energy aware.

This means that more energy is conserved when using FACO as compared to ACO routing algorithm because we are losing more energy in ACO technique. There is an increase in the performance of the proposed algorithm which means that WSNs will be more reliable and efficient.

$$E_{inc} = \frac{E_{FACO} - E_{ACO}}{E_{ACO}} * 100 \%$$

(4.5)

$$E_{inc} = \frac{2.8 - 1.4}{1.4} * 100 \% = 100 \%$$

Where E_{inc} is the percentage increase in the energy level of a node, E_{FACO} is the energy level for FACO and E_{ACO} is the energy level for ACO.

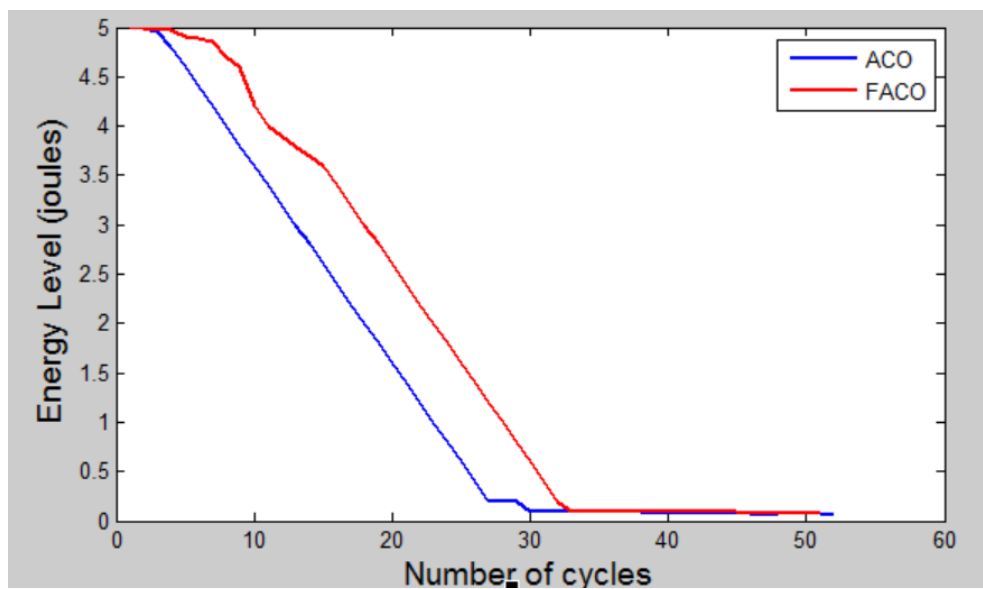

Figure 4.14 Performance of FACO compared to ACO for energy level

Table 4.5 shows the impact of the three parameters (Packet delivery, energy level and number of dead nodes) to the network lifetime. For ACO more nodes are dead and the energy consumed is high. The number of packets delivered are as well were higher for FACO as compared to ACO. In overall there is an increased performance in the proposed routing algorithm in energy conservation of WSNs. The number of packets delivered increased by 18.25 %, the number of dead nodes decreased by 40 % meaning

more nodes were available for data transmission and the energy level increased by 100% for FACO as compared to ACO routing protocol.

Table 4.5 Performance comparison of FACO and ACO on network lifetime

Parameter	ACO	FACO
Number of packets delivered to the sink node at cycle 50	170 bits	201 bits
Energy level at cycle 20	1.4 Joules	2.8 Joules
Number of dead nodes at cycle 50	45	27

Table 4.6 shows comparison of proposed technique with other techniques. The proposed technique outperforms the other methods of routing for WSNs.

Table 4.6 Performance comparison of proposed technique with other techniques

Approach	Mac routing FLACO ref[23]	Type 2 FLACO ref [21]	ACO ref [29]	Proposed method
Number of packets delivered to the sink node for 50 cycles (bits)	180	187	170	201
Energy level for 20 cycles (joules)	1.6	1.9	1.4	2.8
Number of dead nodes for 50 cycles	41	38	45	27

CHAPTER FIVE

CONCLUSIONS AND RECOMMENDATIONS

WSN are limited in energy because they rely on battery and hence there is need for energy efficient routing protocol. The designed routing protocol is energy aware, distance aware and data aware. The results have shown improved performance in terms of the number of packets delivered to the sink node, the energy level in the node and the number of dead nodes. FACO routing protocol has shown improved lifetime of WSNs as compared to the performance of ACO and so it can be applied in industrial applications to enhance reliability and efficiency of the system.

5.1 Conclusions

- The developed routing model satisfactorily lead to energy conservation of WSNs as they rely on battery as their source of energy. The optimization of the routing model using FACO lead to development of energy efficient routing model.
- The simulation from Matlab C code showed enhanced network lifetime by providing a balance between the energy level, number of packets delivered to the sink node and the number of dead nodes.
- The results from simulation showed an improved performance of WSNs based on FACO as compared to ACO. The parameters considered were number of packets delivered to the sink node, the energy consumption and the number of dead nodes in the queue. The number of packets delivered increased by 18.25 %,

the number of dead nodes decreased by 40 % meaning more nodes were available for data transmission and the energy level increased by 100% for FACO as compared to ACO routing protocol.

- The routing protocol is expected to provide increased reliability and efficiency if used for WSN in industrial applications.

5.2 Recommendations

The analysis done on this thesis was based on three parameters for WSNs which include the energy of the node, the data in the queue and the distance from source to sink node. The possibility of including other parameters that affect the energy consumption of WSNs can be analyzed and investigated. These parameters to be investigated are transmission time and number of retransmitted packets to avoid collision.

REFERENCES

- [1] Mohammed Alsheik, Shaowei Lin, Dusit Niyato et al, Machine learning in wireless sensor networks algorithms, strategies and applications, vol. 4, IEEE communications & surveys & tutorials, 2014.
- [2] Silicon Labs Report, "Evolution of wireless sensor networks", Silicon laboratories Inc., 2013.
- [3] Yingshu Li and My T. Thai, *Wireless sensor network applications*, Springer, 2008, pp. 456-687.
- [4] Kazem Sohraby, Daniel Minoli and Taieb Znati, *wireless sensor networks technology, protocols and applications*, John Willey and sons, 2007, pp. 203-209.
- [5] Walteneus Dargie and Christian Poellabauer, *Fundamentals of wireless sensor networks theory and practice*, John Wiley and sons, 2010, pp. 168-192.
- [6] Dr. Shu Yinbiao, Dr. Kang Lee, Peter Lanctot et al, "Internet of things wireless sensor networks white paper", China: IEC market strategy board, 2014.
- [7] Mareca Halter, Darryl Gurganious and Jeff Kreegar "Industrial wireless sensor networks," A market dynamics report ON world, 2017.
- [8] Shu-Yin and Jing-Long, "Routing analysis using fuzzy logic systems in wireless sensor networks," *Springer verlag Berlin Heidelberg*, pp. 966-973, 2008.

- [9] Theodore Kotsilieris and George Karetsos, "Prolonging the lifetime of two tiered wireless sensor network with mobile relays," *Hindawi publishing corporation*, 2013.
- [10] P. Mohammed, "Bokhari-Sepel routing protocol based on fuzzy logic wireless sensor networks," *International conference on reliability information technologies and optimization(ICRITO)*, 2016.
- [11] S. Babar, "Fuzzy logic based guaranteed lifetime protocol for real time wireless sensor networks," *sensors 2015*, pp. 20373-20391, 2015.
- [12] Ibrahim M. and S. Ramakrishnan, *Wireless sensor networks from theory to application*, CRC press, 2013, pp. 100-200.
- [13] Mohammad S. Obaidat and Sudip, *Principles of wireless sensor networks*, UK: Cambridge university press, 2014.
- [14] Ahmed Alkadhmaee and Songfeng Lu, "Prolonging the network lifetime based on LPA-star algorithm and fuzzy logic in wireless sensor networks," *12th world congress on intelligent control and automation (WCICA)*, pp. 1448-1453, 2016.
- [15] E. N. Onwuka, M. Saidu and A. Umar "An enhanced algorithm for energy conservation in LEACH routing for wireless sensor networks," *MECS press IJ microwave technologies*, vol. 4, pp. 59-71, 2016.
- [16] Ali Ghaffari, "An energy efficient routing protocol for wireless sensor networks using A-star algorithm," *Journal of applied research & technology*, pp. 815-822,

2017.

- [17] J. N. Al-Karaki and A. E. Kamal, "Routing techniques in wireless sensor networks; A survey," *IEEE wireless communication*, vol. 11, no. 6, 2012.
- [18] Hasan Farooq and Low Tang Jung, "Energy, data, load and link quality aware adhoc routing protocol for wireless sensor networks based smart metering infrastructure," *International journal of distributed sensor networks*, 2013.
- [19] P. Anuja, "Energy efficient lifetime improving and secure periodic data collection protocol for wireless sensor networks," *International journal on computational science and applications(IJCSA)*, vol. 6, no. 3, 2016.
- [20] Mohamed Ezz and Abdi El Kader, "Energy aware and adaptive cross-layer schemes for video transmission over wireless sensor networks," *IEEE sensors journal*, vol. 16, no. 21, 2016.
- [21] Q.-y. Zhang, "A clustering routing protocol for wireless sensor networks based on type-2 fuzzy logic and ACO," *IEEE International conference on fuzzy systems(FUZZ-IEEE)*, pp. 1060-1067, 2014.
- [22] S. Ratnajeewan and H. Hoole., *Advance in Electronic and Electric Engineering*, Research India Publications, vol. 4, pp. 475-486, 2014.
- [23] Sachin Gajjar, Mohabchur Sarkar and Kankar Dasgupta, "Fuzzy and ant colony optimization based mac/routing cross-layer protocol for wireless sensor networks," *Elsevier B.V*, pp. 1014-1021, 2015.

- [24] Swati Atri, Dr. Nasib and Jaideep Atri, "Fuzzy logic implementation of ant colony based clusterhead selection algorithm," *International journal of advanced research in computer and communication engineering*, vol. 3, no. 4, pp. 6256-6259, 2014.
- [25] Ruqiang Yan, Hanghang Sun and Yuning Qian, "Energy aware sensor node design with its applications in wireless sensor networks," *IEEE transactions on instrumentation and measurement*, vol. 62, no. 5, pp. 1183-1191, 2013.
- [26] Yan-Fei, Chen-Xu Zhao, Long Xu et al "Research and application of WSN Technology in the contact points of distribution transformer," *Journal of clean Energy Technologies*, vol. 2, no. 1, 2014.
- [27] Sidra Rashid, Usman Akram, Saad Qaisar et al "Wireless sensor network for distributed event detection based on machine learning," *IEEE International Conference on Internet of Things*, 2014.
- [28] Joy Weiss and Ross Yu, "Wireless sensor networking for industrial IOT," Available:[http://electronicdesign.com/print/iot/wireless-sensor-networking-industrial IOT](http://electronicdesign.com/print/iot/wireless-sensor-networking-industrial-IOT), 2015.
- [29] Rajeev Arya and S.C. Sharma, "Analysis and optimization of energy of sensor node using ACO in wireless sensor network," *International Conference on Advanced Computing Technologies and Applications (ICACTA)*, 2015.
- [30] Chandni, Kanika Sharma and Himanshu Monga "Improved Termite-hill routing protocol using ACO in wireless sensor networks," *international computer science*

and engineering conference (ICSEC), pp. 365-370, 2013.

- [31] Tina Gui, Christopher Ma, Feng Wang et al, "Survey of swarm intelligence based routing protocols for wireless sensor networks," *IEEE*, pp. 1944-1949, 2016.
- [32] Ehsan Amiri, Hassan Keshavarz, Mojtaba Alizadeh et al, "Energy efficient routing in wireless sensor networks based on fuzzy ant colony optimization," *International journal of distributed sensor networks*, 2014.
- [33] Ali Zilouchian and Mo Jamshidi, *Intelligent control systems using soft computing methodologies*, Newyork: CRC press, 2012, pp. 189-280.
- [34] Hung T. Nguyen, Nadipuram R. Prasad and Elbert A. Walker, *A first course in fuzzy and neural control*, New york: CRC press, 2011, pp. 85-120.
- [35] Fakhreddine O. Karray and Clarence De Silva, *Soft computing and intelligent system design theory tools and application*, Addison Wesley, 2012, pp. 6-37.
- [36] Radim Belohlavek and George J. Klir, *Concepts and fuzzy logic*, MIT press, 2011.
- [37] A. K. Bhargava, *Fuzzy set theory, fuzzy logic and their application*, India: S. Chand and company PVT limited, 2013.
- [38] Marco Dorigo and Thomas Stutzle, *Ant colony optimization*, MIT press, 2012, pp. 65-100.
- [39] Dan Simon, *Evolutionary optimization algorithms*, Canada: John Wiley and sons, 2013.

[40] Julia Pizzo, *Ant colony optimization*, India; Clanrye International, 2015.

[41] Annu Ghotra, "Ant Colony Optimization: Inter cluster Ant Colony Optimization and Rendezvous nodes based Mobile Sink in WSN," *LAP LAMBERT Academic Publishing*, 2015.

APPENDICES

Appendix A: Simulation Code

//Fuzzy System code

```
Name='sensornew'  
Type='mamdani'  
Version=2.0  
NumInputs=2  
NumOutputs=1  
NumRules=9  
AndMethod='min'  
OrMethod='max'  
ImpMethod='min'  
AggMethod='max'  
DefuzzMethod='centroid'  
[Input1]  
Name='energy'  
Range=[0 5]  
NumMFs=3  
MF1='low': 'trapmf',[0 0 0.7 2]  
MF2='medium': 'trimf',[0.5 2.5 4.5]  
MF3='High': 'trapmf',[3.5 4.5 5 5]  
[Input2]  
Name='data'  
Range=[0 10]  
NumMFs=3  
MF1='low': 'trapmf',[0 0 2 5]  
MF2='medium': 'trimf',[3 5 8]  
MF3='high': 'trapmf',[6.4 8.5 10 10]  
[Output1]  
Name='cost'  
Range=[0 10]  
NumMFs=5  
MF1='verysmall': 'trapmf',[-2.25 -0.25 0.25 2.25]  
MF2='small': 'trimf',[0 2.5 5]
```

MF3='medium': 'trimf', [2.5 5 7.5]
MF4='Large': 'trimf', [5 7.5 10]
MF5='Verylarge': 'trapmf', [7.75 9.75 10.25 12.25]

[Rules]

1 1, 3 (1) : 1
1 2, 2 (1) : 1
1 3, 1 (1) : 1
2 1, 4 (1) : 1
2 2, 3 (1) : 1
2 3, 2 (1) : 1
3 1, 5 (1) : 1
3 2, 4 (1) : 1
4 3, 3 (1) : 1

Appendix B: Publication

[1] Veronicah M. Mualuko, Peter K. Kihato and Vitalice Oduol, " Routing Optimization for Wireless Sensor Networks using Fuzzy Ant Colony," International Journal of Applied Engineering Research ISSN 0973-4562 Volume 12, Number 21 (2017) pp. 11606-11613.